







Catalog Contents

PAGE	PAGE TITLE	PAGE	PAGE TITLE	PAGE	PAGE TITLE
2 - 3	Introduction & Content	32	Steel A-Frames	56	X-Stands
4 - 5	Advertising Display Flags	33	Aluminum A-Frames	57	Versatile Displays
6 - 7	ADF Accessories	34	Sidewalk Signs	58 - 59	SEG Frames
8 - 9	Custom Traditional Flutter Flags	35	Signcade Deluxe Signs	60 - 61	Table Drapes
10 - 11	Stock Flutter Flags	36	Trek Retractors	62 - 63	Stretch Table Covers
12 - 13	Neon Capabilities	37	Roll N' Go Displays	64	Table Runners & Throws
14 - 15	Custom Flags	38 - 39	Realty Signs	65	Convertible Table Covers
16 - 17	Euro Flags	40	Lightweight A-Frame Pop-Ups	66 - 67	The Halo Banners
18 - 19	Table Top Flags	41	Human Directional & Yard Signs	68 - 69	Avenue Banners
20	Golf Flags	42 - 43	Inflatable Displays	70 - 71	The Commercial Tents
21	Stick Flags	44 - 45	Expandable Pop-Up Walls	72 - 73	The PRO Tents
22	Tear Away Banners	46	Tube Display Walls	74 - 75	The Promo Tents
23	Spirit Flags	47	Tradeshaw SEG Displays	76 - 77	Tent Accessories & Walls
24	Car Flags	48	Arrow Tip Sign Holders	78 - 79	Beach Umbrellas
25	Event Flags	49	Promotional Counter & Bar	80	Wood Patio Umbrellas
26	Garden Flags	50 - 51	Table Top Displays	81	Aluminum Patio Umbrellas
27	House Flags	52	Superior Retractable	82 - 83	Wallpapers & Textile Adhesives
28 - 29	Lollipop & Drive Thru Signs	53	Select Retractable		
30	Taut N' Tight Banner Spikes	54	Basic Retractable		
31	Door Frame Banner Kits	55	Jumbo & Switchblade Retractable		

ADVERTISING DISPLAY FLAGS



Unique blade bottom shapes to choose from.



ADVERTISING DISPLAY FLAGS

Our premium advertising display flags have four basic designs:

BLADE, TEARDROP, PREMIUM 90 AND SHARK FIN

These flags are designed specifically for our premium poles. The poles are made of extremely durable fiberglass. The flags and poles are designed to maintain the shape of the flag, allowing visibility of your printed message, even in windless conditions.

We offer a wide selection of ground spikes, bases and mounts to make these flags a perfect solution for any location.

SIZING & CONSTRUCTION

SINGLE REVERSE v. **DOUBLE SIDED**

Single Reverse prints have a 90% penetration rate and show the reverse image of the front side.

Double Sided prints can have two different designs on each side and have a liner sewn in between to keep images from meshing with each other.

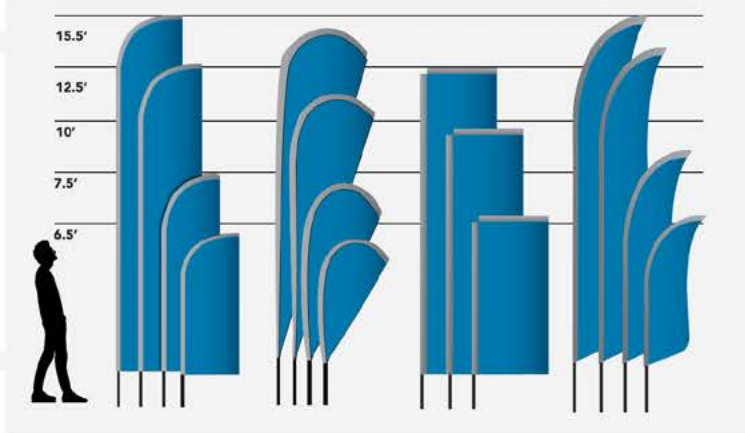



BLADE		DESCRIPTION	SR	ITEM#	DS	ITEM#	GRAPHIC HEIGHT	GRAPHIC WIDTH	TOTAL HEIGHT	TOTAL WIDTH	DEPTH	WEIGHT	MATERIAL
XTRA-SMALL		Flag Only		FLT4265		FLT4270	60"	16.5"	60"	16.5"	-	1.5 lbs	Nylon or EverTex®
		Flag + Pole & Spike Kit		FLT4315		FLT4330	60"	16.5"	75"	16.5"	-	8 lbs	+ Fiberglass Poles & Steel
		Flag + Pole & Spider Kit		FLT4320		FLT4335	60"	16.5"	75"	16.5"	-	13 lbs	+ Plastic Water Bag
		Flag + Deluxe Kit		FLT4325		FLT4340	60"	16.5"	75"	16.5"	-	15.5 lbs	All the Above
SMALL		Flag Only		FLT1030		FLT1035	84.5"	27"	87"	27"	-	1.5 lbs	Nylon or EverTex®
		Flag + Pole & Spike Kit		FLT3795		FLT3800	84.5"	27"	102.5"	27"	-	8 lbs	+ Fiberglass Poles & Steel
		Flag + Pole & Spider Kit		FLT3805		FLT3810	84.5"	27"	102.5"	27"	-	13 lbs	+ Plastic Water Bag
		Flag + Deluxe Kit		FLT3815		FLT3820	84.5"	27"	102.5"	27"	-	15.5 lbs	All the Above
MEDIUM		Flag Only		FLT1080		FLT1085	112"	29.75"	114"	29.75"	-	1.75 lbs	Nylon or EverTex®
		Flag + Pole & Spike Kit		FLT3825		FLT3830	112"	29.75"	150"	29.75"	-	8.25 lbs	+ Fiberglass Poles & Steel
		Flag + Pole & Spider Kit		FLT3835		FLT3840	112"	29.75"	150"	29.75"	-	13.25 lbs	+ Plastic Water Bag
		Flag + Deluxe Kit		FLT3845		FLT3850	112"	29.75"	150"	29.75"	-	15.75 lbs	All the Above
LARGE		Flag Only		FLT1130		FLT1135	163"	33.75"	163"	33.75"	-	2 lbs	Nylon or EverTex®
		Flag + Pole & Spike Kit		FLT3855		FLT3860	163"	33.75"	189"	33.75"	-	8.5 lbs	+ Fiberglass Poles & Steel
		Flag + Pole & Spider Kit		FLT3865		FLT3870	163"	33.75"	189"	33.75"	-	13.5 lbs	+ Plastic Water Bag
		Flag + Deluxe Kit		FLT3875		FLT3880	163"	33.75"	189"	33.75"	-	16 lbs	All the Above

*Choose between 4 different blade bottom shapes as seen on page 4



TEARDROP		DESCRIPTION	SR	ITEM#	DS	ITEM#	GRAPHIC HEIGHT	GRAPHIC WIDTH	TOTAL HEIGHT	TOTAL WIDTH	DEPTH	WEIGHT	MATERIAL
XTRA-SMALL		Flag Only		FLT4275		FLT4280	60"	25"	60"	25"	-	1.5 lbs	Nylon or EverTex®
		Flag + Pole & Spike Kit		FLT4345		FLT4360	60"	25"	72"	25"	-	8 lbs	+ Fiberglass Poles & Steel
		Flag + Pole & Spider Kit		FLT4350		FLT4365	60"	25"	72"	25"	-	13 lbs	+ Plastic Water Bag
		Flag + Deluxe Kit		FLT4355		FLT4370	60"	25"	72"	25"	-	15.5 lbs	All the Above
SMALL		Flag Only		FLT1020		FLT1025	77.5"	31.75"	77.5"	31.75"	-	1.5 lbs	Nylon or EverTex®
		Flag + Pole & Spike Kit		FLT3885		FLT3890	77.5"	31.75"	87.5"	31.75"	-	8 lbs	+ Fiberglass Poles & Steel
		Flag + Pole & Spider Kit		FLT3895		FLT3900	77.5"	31.75"	87.5"	31.75"	-	13 lbs	+ Plastic Water Bag
		Flag + Deluxe Kit		FLT3905		FLT3910	77.5"	31.75"	87.5"	31.75"	-	15.5 lbs	All the Above
MEDIUM		Flag Only		FLT1070		FLT1075	116.5"	34.5"	116.5"	34.5"	-	1.75 lbs	Nylon or EverTex®
		Flag + Pole & Spike Kit		FLT3915		FLT3920	116.5"	34.5"	132"	34.5"	-	8.25 lbs	+ Fiberglass Poles & Steel
		Flag + Pole & Spider Kit		FLT3925		FLT3930	116.5"	34.5"	132"	34.5"	-	13.25 lbs	+ Plastic Water Bag
		Flag + Deluxe Kit		FLT3935		FLT3940	116.5"	34.5"	132"	34.5"	-	15.75 lbs	All the Above
LARGE		Flag Only		FLT1120		FLT1125	156"	37"	156"	37"	-	2 lbs	Nylon or EverTex®
		Flag + Pole & Spike Kit		FLT3945		FLT3950	156"	37"	166"	37"	-	8.5 lbs	+ Fiberglass Poles & Steel
		Flag + Pole & Spider Kit		FLT3955		FLT3960	156"	37"	166"	37"	-	13.5 lbs	+ Plastic Water Bag
		Flag + Deluxe Kit		FLT3965		FLT3970	156"	37"	166"	37"	-	16 lbs	All the Above



PREMIUM 90		DESCRIPTION	SR	ITEM#	DS	ITEM#	GRAPHIC HEIGHT	GRAPHIC WIDTH	TOTAL HEIGHT	TOTAL WIDTH	DEPTH	WEIGHT	MATERIAL
SMALL		Flag Only		FLT1050		FLT1055	72"	36"	72"	36"	-	1.5 lbs	Nylon or EverTex®
		Flag + Pole & Spike Kit		FLT4065		FLT4070	72"	36"	78"	36"	-	8 lbs	+ Fiberglass Poles & Steel
		Flag + Pole & Spider Kit		FLT4075		FLT4080	72"	36"	78"	36"	-	13 lbs	+ Plastic Water Bag
		Flag + Deluxe Kit		FLT4085		FLT4090	72"	36"	78"	36"	-	15.5 lbs	All the Above
MEDIUM		Flag Only		FLT1100		FLT1105	103"	36"	100"	36"	-	1.5 lbs	Nylon or EverTex®
		Flag + Pole & Spike Kit		FLT4095		FLT4100	103"	36"	120"	36"	-	8 lbs	+ Fiberglass Poles & Steel
		Flag + Pole & Spider Kit		FLT4105		FLT4110	103"	36"	120"	36"	-	13 lbs	+ Plastic Water Bag
		Flag + Deluxe Kit		FLT4115		FLT4120	103"	36"	120"	36"	-	15.5 lbs	All the Above
LARGE		Flag Only		FLT1150		FLT1155	147"	36"	150"	36"	-	1.75 lbs	Nylon or EverTex®
		Flag + Pole & Spike Kit		FLT4125		FLT4130	147"	36"	150"	36"	-	8.25 lbs	+ Fiberglass Poles & Steel
		Flag + Pole & Spider Kit		FLT4135		FLT4140	147"	36"	150"	36"	-	13.25 lbs	+ Plastic Water Bag
		Flag + Deluxe Kit		FLT4145		FLT4150	147"	36"	150"	36"	-	15.75 lbs	All the Above



SHARK FIN		DESCRIPTION	SR	ITEM#	DS	ITEM#	GRAPHIC HEIGHT	GRAPHIC WIDTH	TOTAL HEIGHT	TOTAL WIDTH	DEPTH	WEIGHT	MATERIAL
XTRA-SMALL		Flag Only		FLT4285		FLT4290	60"	16.5"	60"	16.5"	-	1.5 lbs	Nylon or EverTex®
		Flag + Pole & Spike Kit		FLT4375		FLT4390	60"	16.5"	75"	16.5"	-	8 lbs	+ Fiberglass Poles & Steel
		Flag + Pole & Spider Kit		FLT4380		FLT4395	60"	16.5"	75"	16.5"	-	13 lbs	+ Plastic Water Bag
		Flag + Deluxe Kit		FLT4385		FLT4400	60"	16.5"	75"	16.5"	-	15.5 lbs	All the Above
SMALL		Flag Only		FLT3715		FLT3720	84.5"	27"	84.5"	27"	-	1.5 lbs	Nylon or EverTex®
		Flag + Pole & Spike Kit		FLT3975		FLT3980	84.5"	27"	102.5"	27"	-	8 lbs	+ Fiberglass Poles & Steel
		Flag + Pole & Spider Kit		FLT3985		FLT3990	84.5"	27"	102.5"	27"	-	13 lbs	+ Plastic Water Bag
		Flag + Deluxe Kit		FLT3995		FLT4000	84.5"	27"	102.5"	27"	-	15.5 lbs	All the Above
MEDIUM		Flag Only		FLT3725		FLT3730	112"	29.75"	112"	29.75"	-	1.75 lbs	Nylon or EverTex®
		Flag + Pole & Spike Kit		FLT4005		FLT4010	112"	29.75"	150"	29.75"	-	8.25 lbs	+ Fiberglass Poles & Steel
		Flag + Pole & Spider Kit		FLT4015		FLT4020	112"	29.75"	150"	29.75"	-	13.25 lbs	+ Plastic Water Bag
		Flag + Deluxe Kit		FLT4025		FLT4030	112"	29.75"	150"	29.75"	-	15.75 lbs	All the Above
LARGE		Flag Only		FLT3735		FLT3740	163"	33.75"	163"	33.75"	-	2 lbs	Nylon or EverTex®
		Flag + Pole & Spike Kit		FLT4035		FLT4040	163"	33.75"	189"	33.75"	-	8.5 lbs	+ Fiberglass Poles & Steel
		Flag + Pole & Spider Kit		FLT4045		FLT4050	163"	33.75"	189"	33.75"	-	13.5 lbs	+ Plastic Water Bag
		Flag + Deluxe Kit		FLT4055		FLT4060	163"	33.75"	189"	33.75"	-	16 lbs	All the Above

THE VERY BEST HARDWARE AVAILABLE! WORLD CLASS QUALITY

ADVERTISING DISPLAY FLAG ACCESSORIES

Our Premium Advertising Display Poles are the most durable and highest quality on the market. These sectional poles are made of a flexible fiberglass and graphite composite. The rotating spike has stainless steel bearings and a coated steel base for maximum durability.

Hardware can be sold as a kit or individual components. Our basic kit includes a sectional pole, rotating ground spike and durable travel bag.



EASY TO LINK
TOGETHER

FIBERGLASS
GRAPHITE POLES
WITH EXTREME
FLEXIBILITY

BLADE \ TEARDROP \ SHARK FIN POLE KIT SETS

	DESCRIPTION	ITEM#	TOTAL HEIGHT	TOTAL WIDTH	TOTAL DEPTH	WEIGHT	MATERIAL
XTRA-SMALL	Basic Kit	FLT3780	72" / 75.5"	0.25" / 8"	0.25" / 0.25"	0.5 lb	Fiberglass & Polyester Bag
	Pole & Spike Kit	FLT4300	VIEW ACCESSORY SPECS ON PAGE 7	VIEW ACCESSORY SPECS ON PAGE 7	VIEW ACCESSORY SPECS ON PAGE 7	2.5 lbs	Fiberglass, Steel & Polyester Bag
	Pole & Spider Kit	FLT4305	"	"	"	8 lbs	Fiberglass, Steel, Plastic & Polyester Bag
	Deluxe Pole Kit	FLT4310	"	"	"	10 lbs	Fiberglass, Steel, Plastic & Polyester Bag
SMALL	Basic Kit	FLT1160	108" / 75.5"	0.25" / 8"	0.25" / 0.25"	0.5 lb	Fiberglass & Polyester Bag
	Pole & Spike Kit	FLT1265	VIEW ACCESSORY SPECS ON PAGE 7	VIEW ACCESSORY SPECS ON PAGE 7	VIEW ACCESSORY SPECS ON PAGE 7	2.5 lbs	Fiberglass, Steel & Polyester Bag
	Pole & Spider Kit	FLT1280	"	"	"	8 lbs	Fiberglass, Steel, Plastic & Polyester Bag
	Deluxe Pole Kit	FLT1295	"	"	"	10 lbs	Fiberglass, Steel, Plastic & Polyester Bag
MEDIUM	Basic Kit	FLT1165	148.5" / 75.5"	0.25" / 8"	0.25" / 0.25"	1 lb	Fiberglass & Polyester Bag
	Pole & Spike Kit	FLT1270	VIEW ACCESSORY SPECS ON PAGE 7	VIEW ACCESSORY SPECS ON PAGE 7	VIEW ACCESSORY SPECS ON PAGE 7	3 lbs	Fiberglass, Steel & Polyester Bag
	Pole & Spider Kit	FLT1285	"	"	"	8.5 lbs	Fiberglass, Steel, Plastic & Polyester Bag
	Deluxe Pole Kit	FLT1300	"	"	"	10.5 lbs	Fiberglass, Steel, Plastic & Polyester Bag
LARGE	Basic Kit	FLT1170	198.5" / 75.5"	0.25" / 8"	0.25" / 0.25"	1.5 lbs	Fiberglass & Polyester Bag
	Pole & Spike Kit	FLT1275	VIEW ACCESSORY SPECS ON PAGE 7	VIEW ACCESSORY SPECS ON PAGE 7	VIEW ACCESSORY SPECS ON PAGE 7	3.5 lbs	Fiberglass, Steel & Polyester Bag
	Pole & Spider Kit	FLT1290	"	"	"	9 lbs	Fiberglass, Steel, Plastic & Polyester Bag
	Deluxe Pole Kit	FLT1305	"	"	"	11 lbs	Fiberglass, Steel, Plastic & Polyester Bag

POLE & SPIKE KIT INCLUDES: Pole Kit, Travel Bag & Spike **POLE & SPIDER KIT INCLUDES:** Pole Kit, Travel Bag, Spider Base & Water Bag
DELUXE POLE KIT: Pole Kit, Travel Bag, Spike, Spider Base & Water Bag

PREMIUM 90 POLE KIT SETS

	DESCRIPTION	ITEM#	TOTAL HEIGHT	TOTAL WIDTH	TOTAL DEPTH	WEIGHT	MATERIAL
SMALL	Basic Kit	FLT1190	78" / 75.5"	0.25" / 8"	0.25" / 0.25"	0.5 lb	Fiberglass & Polyester Bag
	Pole & Spike Kit	FLT1825	VIEW ACCESSORY SPECS ON PAGE 7	VIEW ACCESSORY SPECS ON PAGE 7	VIEW ACCESSORY SPECS ON PAGE 7	2.5 lbs	Fiberglass, Steel & Polyester Bag
	Pole & Spider Kit	FLT1840	"	"	"	8 lbs	Fiberglass, Steel, Plastic & Polyester Bag
	Deluxe Pole Kit	FLT2050	"	"	"	10 lbs	Fiberglass, Steel, Plastic & Polyester Bag
MEDIUM	Basic Kit	FLT1195	108" / 75.5"	0.25" / 8"	0.25" / 0.25"	1 lb	Fiberglass & Polyester Bag
	Pole & Spike Kit	FLT1830	VIEW ACCESSORY SPECS ON PAGE 7	VIEW ACCESSORY SPECS ON PAGE 7	VIEW ACCESSORY SPECS ON PAGE 7	3 lbs	Fiberglass, Steel & Polyester Bag
	Pole & Spider Kit	FLT1845	"	"	"	8.5 lbs	Fiberglass, Steel, Plastic & Polyester Bag
	Deluxe Pole Kit	FLT2055	"	"	"	10.5 lbs	Fiberglass, Steel, Plastic & Polyester Bag
LARGE	Basic Kit	FLT1200	151.5" / 75.5"	0.25" / 8"	0.25" / 0.25"	1.5 lbs	Fiberglass & Polyester Bag
	Pole & Spike Kit	FLT1835	VIEW ACCESSORY SPECS ON PAGE 7	VIEW ACCESSORY SPECS ON PAGE 7	VIEW ACCESSORY SPECS ON PAGE 7	3.5 lbs	Fiberglass, Steel & Polyester Bag
	Pole & Spider Kit	FLT1850	"	"	"	9 lbs	Fiberglass, Steel, Plastic & Polyester Bag
	Deluxe Pole Kit	FLT2060	"	"	"	11 lbs	Fiberglass, Steel, Plastic & Polyester Bag

POLE & SPIKE KIT INCLUDES: Pole Kit, Travel Bag & Spike **POLE & SPIDER KIT INCLUDES:** Pole Kit, Travel Bag, Spider Base & Water Bag
DELUXE POLE KIT: Pole Kit, Travel Bag, Spike, Spider Base & Water Bag



DELUXE POLE TRAVEL BAG

ITEM#	GRAPHIC HEIGHT	GRAPHIC WIDTH	TOTAL HEIGHT	TOTAL WIDTH	TOTAL DEPTH	WEIGHT	MATERIAL
FLT4405	-	-	60"	8"	3"	1 lb	Polyester



SPIDER BASE

Spider Base adds great stability and security for all advertising flags. Great for indoor or outdoor use on hard surfaces.

ITEM#	GRAPHIC HEIGHT	GRAPHIC WIDTH	TOTAL HEIGHT	TOTAL WIDTH	TOTAL DEPTH	WEIGHT	MATERIAL
FLT1235	-	-	8"	23"	23"	6.5 lbs	Steel



ROTATING GROUND SPIKE

Spike comes with standard pole kits, purchase only for extra or replacement.

ITEM#	GRAPHIC HEIGHT	GRAPHIC WIDTH	TOTAL HEIGHT	TOTAL WIDTH	TOTAL DEPTH	WEIGHT	MATERIAL
FLT1230	-	-	21"	0.5"	0.5"	2 lbs	Steel



TIRE BASE

*Wheel and tire not included.

ITEM#	GRAPHIC HEIGHT	GRAPHIC WIDTH	TOTAL HEIGHT	TOTAL WIDTH	TOTAL DEPTH	WEIGHT	MATERIAL
FLT1605	-	-	7.5"	19"	-	4.5 lbs	Steel



SPIDER BASE WATER BAG

*Spider Base sold separately

ITEM#	GRAPHIC HEIGHT	GRAPHIC WIDTH	TOTAL HEIGHT	TOTAL WIDTH	TOTAL DEPTH	WEIGHT	MATERIAL
FLT1245	-	-	1"	20"	20"	20 lbs filled	Plastic



SPINNER BASE

The square Spinner Base mount acts as a beautiful indoor stand and keeps premium flags from getting tangled.

ITEM#	GRAPHIC HEIGHT	GRAPHIC WIDTH	TOTAL HEIGHT	TOTAL WIDTH	TOTAL DEPTH	WEIGHT	MATERIAL
FLT3785	-	-	5.5"	17.75"	17.75"	15 lbs	Steel

ANGLED, WALL, FLOOR & TENT MOUNTS



1	ITEM#	GRAPHIC HEIGHT	GRAPHIC WIDTH	TOTAL HEIGHT	TOTAL WIDTH	TOTAL DEPTH	WEIGHT	MATERIAL
ANGLED	FLT1250	-	-	5.5"	4"	4"	1.5 lbs	Steel

2	ITEM#	GRAPHIC HEIGHT	GRAPHIC WIDTH	TOTAL HEIGHT	TOTAL WIDTH	TOTAL DEPTH	WEIGHT	MATERIAL
FLOOR	FLT1260	-	-	5"	4"	4"	1.5 lbs	Steel

3	ITEM#	GRAPHIC HEIGHT	GRAPHIC WIDTH	TOTAL HEIGHT	TOTAL WIDTH	TOTAL DEPTH	WEIGHT	MATERIAL
WALL	FLT1255	-	-	6"	4"	3"	1.5 lbs	Steel

TENT	ITEM#	GRAPHIC HEIGHT	GRAPHIC WIDTH	TOTAL HEIGHT	TOTAL WIDTH	TOTAL DEPTH	WEIGHT	MATERIAL
TENT	TNT1425	-	-	8"	2"	5"	2 lbs	Steel

FLAGS

CUSTOM FEATHER



COMES IN
6
DISTINCT SIZES

CUSTOM FEATHER FLAGS TRADITIONAL STYLE

Our traditional feather & attention flags offer a range of sizes, shapes, and design options that include solid colors, stripes, panels, messages and full custom designs. These flags are designed to go on our fiberglass telescoping poles and are best used in semi-permanent installations. However, with multiple base options and mounts to choose from, you can set up these flags anywhere. In addition to the standard pole sleeve, these attention flags can be finished with canvas header and grommets to be flown on a traditional flag pole.

SR = Single Reverse Flag DS = Double Sided Flag

DESCRIPTION	SR	ITEM#	DS	ITEM#	GRAPHIC HEIGHT	GRAPHIC WIDTH	TOTAL HEIGHT	TOTAL WIDTH	TOTAL DEPTH	WEIGHT	MATERIAL
6' Feather Flag Print (Any Shape)		FLT1320		FLT1325	72"	33"	-	-	-	1 lb	Nylon or EverTex®
8' Feather Flag Print (Any Shape)		FLT1330		FLT1335	96"	33"	-	-	-	1.25 lbs	Nylon or EverTex®
10' Feather Flag Print (Any Shape)		FLT1340		FLT1345	120"	33"	-	-	-	1.4 lbs	Nylon or EverTex®
12' Feather Flag Print (Any Shape)		FLT1350		FLT1355	144"	33"	-	-	-	1.5 lbs	Nylon or EverTex®
15' Feather Flag Print (Any Shape)		FLT1360		FLT1365	180"	33"	-	-	-	1.75 lbs	Nylon or EverTex®
18' Feather Flag Print (Any Shape)		FLT1370		FLT1375	216"	33"	-	-	-	2 lbs	Nylon or EverTex®

Traditional Feather Flags require wind to keep the printed message and/or design visible.

*Use 15' Pole for 6', 8', 10' & 12' Flags. **Use 21' Pole for 15' & 18' Flags. Poles are shipped with a permanent ground sleeve.



TELESCOPING POLES EXTEND UP TO 15' AND 21' FEET

TELESCOPING POLES

Poles come with permanent ground sleeve at base of pole.

DESCRIPTION	ITEM#	GRAPHIC HEIGHT	GRAPHIC WIDTH	TOTAL HEIGHT	TOTAL WIDTH	TOTAL DEPTH	WEIGHT	MATERIAL
15' Telescoping Pole	FLT1575	-	-	185.5"	1.25" Diameter	-	4 lbs	Fiberglass
21' Telescoping Pole	FLT1580	-	-	267.5"	1.5" Diameter	-	5.5 lbs	Fiberglass



18" GROUND STAKE

Used for temporary outdoor settings.

ITEM#	GRAPHIC HEIGHT	GRAPHIC WIDTH	TOTAL HEIGHT	TOTAL WIDTH	TOTAL DEPTH	WEIGHT	MATERIAL
FLT1595	-	-	18"	1.5" Diameter	-	1 lb	Metal



TIRE BASE

*Wheel and tire not included

ITEM#	GRAPHIC HEIGHT	GRAPHIC WIDTH	TOTAL HEIGHT	TOTAL WIDTH	TOTAL DEPTH	WEIGHT	MATERIAL
FLT1605	-	-	7.5"	19"	-	4.5 lbs	Metal



PLASTIC WATER BASE

The perfect base to keep your traditional flutter flag grounded.

ITEM#	GRAPHIC HEIGHT	GRAPHIC WIDTH	TOTAL HEIGHT	TOTAL WIDTH	TOTAL DEPTH	WEIGHT	MATERIAL
FLT1585	-	-	10"	16"	16"	3 lbs without water 30.5 lbs with water	Plastic

SIZING & CONSTRUCTION

SINGLE REVERSE

VS

DOUBLE SIDED



Single Reverse prints have a 90% penetration rate and show the reverse image of the front side.

Double Sided prints can have two different designs on each side and have a liner sewn in between to keep images from meshing with each other.

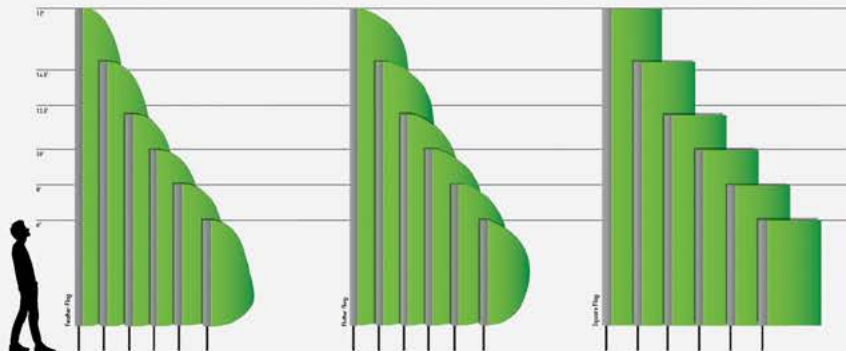

FLAGS

STOCK ATTENTION



STOCK, STRIPED & MESSAGE FLAGS

Choose from an assortment of colors and designs. Utilize our stock messages or print a custom message. Messages are traditionally printed in black and our finishing options are canvas header & grommets or pole sleeve.

Vertical Message Feather Flags are available in 3 shapes: FEATHER, FLUTTER, & RECTANGLE



POLE SLEEVE



CANVAS HEADER & GROMMETS

VERTICAL STRIPED MESSAGE

SR = Single Reverse DS = Double Sided

CUSTOM ITEM#

SR	STOCK MESSAGE ITEM#	DS	STOCK MESSAGE ITEM#	SIZE	WEIGHT	SR	CUSTOM MESSAGE ITEM#	DS	CUSTOM MESSAGE ITEM#
	FLT31X0		FLT31X5	6' x 33"	1 lb		FLT1725		FLT1755
	FLT32X0		FLT32X5	8' x 33"	1.25 lbs		FLT1730		FLT1760
	FLT33X0		FLT33X5	10' x 33"	1.4 lbs		FLT1735		FLT1765
	FLT34X0		FLT34X5	12' x 33"	1.5 lbs		FLT1740		FLT1770
	FLT35X0		FLT35X5	15' x 33"	1.75 lbs		FLT1745		FLT1775
	FLT36X0		FLT36X5	18' x 33"	2 lbs		FLT1750		FLT1780

X = Fill Out with Stock Message Suffix below



HORIZONTAL STRIPED MESSAGE

CUSTOM ITEM#

SR	STOCK MESSAGE ITEM#	DS	STOCK MESSAGE ITEM#	SIZE	WEIGHT	SR	CUSTOM MESSAGE ITEM#	DS	CUSTOM MESSAGE ITEM#
	FLT29X0		FLT29X5	3' x 5'	0.5 lb		FLT2350		FLT2360
	FLT30X0		FLT30X5	4' x 6'	0.75 lb		FLT2355		FLT2365
	FLT45X0		FLT45X5	5' x 8'	0.75 lb		FLT4415		FLT3710



* STOCK MESSAGE EXAMPLE ABOVE
(use message suffix below)

ITEM NUMBER: FLT2910

SIZE: 3' x 5'

TOP STRIPE: OG Red

BOTTOM STRIPE: Royal Blue

STOCK MESSAGE: OPEN

STOCK MESSAGE CODE

WELCOME	OPEN	GRAND OPENING	SALE	LEASING	NOW LEASING	NEW CARS	USED CARS	TRUCKS	USED TRUCKS
0	1	2	3	4	5	6	7	8	9

STOCK NYLON COLORS

70 COLORS AVAILABLE

French Blue PMS 285	Royal Blue PMS 288	Deep Blue PMS 2738	Peacock PMS 2840
Purple PMS 2865	Legion Blue PMS 2758	OG Blue (Navy) PMS 2768	Lilac PMS 2855
Lavendar PMS 2867	Pansy PMS 2827	Parrot Blue PMS 321	Turquoise PMS 3143
D.A.R. Blue PMS 315	Teal PMS 318	Blue Flower PMS 2875	Bluebird PMS 282
Process Blue PMS 2868	Bell Blue PMS 3016	UN Blue PMS 279	Scarab Green PMS 308
Mint Green PMS 388	Bright Green PMS 308	Irish Green PMS 349	Emerald PMS 3425
Dartmouth Green PMS 389	Olive Green PMS 373	Seafoam PMS 332	Aqua PMS 338
Golden Poppy PMS 381	Int'l Orange PMS 382	Burnt Orange PMS 388	Orange PMS 172
Flame PMS 182	Warm Red WARM RED C	Bright Red PMS 185	Canada Red PMS 188
OG Red PMS 201	Brick Red PMS 202	Gold Brown PMS 472	Khaki PMS 738
Sandalwood PMS 188	Spice Brown PMS 1545	Black BLACK C	Lime PMS 388
FM Yellow PMS 108	Daffodil PMS 883	Spanish Yellow PMS 1235	Mustard PMS 138
Violet PMS 2385 <small>INDOOR ONLY</small>	Bone PMS 401	Flesh PMS 4905	Peach PMS 1580
Buff PMS 1385	Gold PMS 143	Light Tan PMS 725	Tan PMS 1390
Amber PMS 157	Rust PMS 167	Mauve PMS 257	Crocus PMS 211
Orchid PMS 240	Dahlia PMS 2415	Wineberry PMS 222	Crimson PMS 214
Magenta PMS 226	Ruby PMS 228	Silver PMS 427	Grey PMS 428
Nickel PMS 429	Charcoal PMS 431		



2 STRIPES

ITEM#	SIZE	WEIGHT
FLT1560	6' x 33"	1 lb
FLT1565	8' x 33"	1 lb
FLT1570	10' x 33"	1.25 lbs
FLT1620	12' x 33"	1.5 lbs
FLT1625	15' x 33"	1.75 lbs
FLT1630	18' x 33"	2 lbs

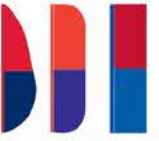

2 PANELS

ITEM#	SIZE	WEIGHT
FLT1665	6' x 33"	1 lb
FLT1670	8' x 33"	1 lb
FLT1675	10' x 33"	1.25 lbs
FLT1680	12' x 33"	1.5 lbs
FLT1685	15' x 33"	1.75 lbs
FLT1690	18' x 33"	2 lbs



SOLID COLORS

ITEM#	SIZE	WEIGHT
FLT1500	6' x 33"	1 lb
FLT1505	8' x 33"	1 lb
FLT1510	10' x 33"	1.25 lbs
FLT1515	12' x 33"	1.5 lbs
FLT1520	15' x 33"	1.75 lbs
FLT1525	18' x 33"	2 lbs



3 STRIPES

ITEM#	SIZE	WEIGHT
FLT2800	6' x 33"	1 lb
FLT2805	8' x 33"	1 lb
FLT2810	10' x 33"	1.25 lbs
FLT2815	12' x 33"	1.5 lbs
FLT2820	15' x 33"	1.75 lbs
FLT2825	18' x 33"	2 lbs



3 PANELS

ITEM#	SIZE	WEIGHT
FLT2770	6' x 33"	1 lb
FLT2775	8' x 33"	1 lb
FLT2780	10' x 33"	1.25 lbs
FLT2785	12' x 33"	1.5 lbs
FLT2790	15' x 33"	1.75 lbs
FLT2795	18' x 33"	2 lbs



SOLID COLORS

ITEM#	SIZE	WEIGHT
FLT2160	2' x 3'	1 lb
FLT2165	3' x 5'	1 lb
FLT2170	4' x 6'	1.25 lbs
FLT2175	5' x 8'	1.5 lbs
FLT2180	6' x 10'	1.75 lbs



2 STRIPES

ITEM#	SIZE	WEIGHT
FLT2185	2' x 3'	1 lb
FLT2190	3' x 5'	1 lb
FLT2195	4' x 6'	1.25 lbs
FLT2200	5' x 8'	1.5 lbs
FLT2205	6' x 10'	1.75 lbs



3 STRIPES

ITEM#	SIZE	WEIGHT
FLT2830	2' x 3'	1 lb
FLT2835	3' x 5'	1 lb
FLT2840	4' x 6'	1.25 lbs
FLT2845	5' x 8'	1.5 lbs
FLT2850	6' x 10'	1.75 lbs

Say it in
Neon

NEON PRINTS FLAGS, BANNERS & DISPLAYS

Have your products stand out when you print on our neon flag material. This material is extremely vibrant and is sure to capture the attention of everyone that walks by.

RECOMMENDATIONS:

When printing on our neon material we suggest using black only. Any other color will blend with the neon and not come out as you might intend.

HOW TO DESIGN IT:

You can use **(A)** black for the color of your message or logo or **(B)** as a mask to knock out the neon underneath.

**LET
YOUR
SALES
REPRESENTATIVE
KNOW WHAT
YOU NEED!**



★ **GRAND** ★ ★ ★ ★
OPENING



- Flags
- Car Flags
- Garden Flags
- Golf Flags
- and more...

YOU TELL US WHAT
YOU **WANT** AND
WE CAN DO IT IN
NEON!



THE BEST CUSTOM FLAGS ON THE MARKET DYE PRINTED FLAGS

We produce brilliantly colored, custom printed flags. We dye print our products by digitally printing with the highest quality equipment in the world. We can also screen print the flags with brilliant dyestar inks. Our dye printing saturates the UV-protected materials with fade resistant inks, ensuring the longest lasting, highest quality printing in the world. Flags can be printed as single reverse or double sided. We also offer different sizes and shapes of finishing. Flags can be printed on our proprietary EverTex® material or on nylon.

MATERIALS

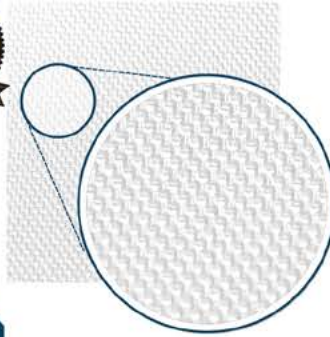

Nylon is a durable, UV-protected material for outdoor prints and the industry standard for flags.

NYLON

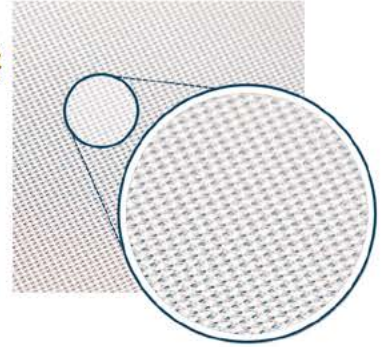

EverTex® is our proprietary flag material made of a highly durable, knitted polyester. We believe it is the longest lasting, most durable flag material in the world. We are proud to introduce to you what we believe will revolutionize the American flag market.

EVERTEX®

SR – Single Reverse Flag

DS – Double Sided Flag

DESCRIPTION	SR	ITEM#	DS	ITEM#	GRAPHIC HEIGHT	GRAPHIC WIDTH	TOTAL HEIGHT	TOTAL WIDTH	TOTAL DEPTH	WEIGHT	MATERIAL
8" x 12" - 2 Grommets, 2 rows of lock stitching on the fly-end		FLG1010		FLG1015	8"	12"	-	-	-	0.25 lb	Nylon or EverTex®
12" x 18" - 2 Grommets, 2 rows of lock stitching on the fly-end		FLG1020		FLG1025	12"	18"	-	-	-	0.25 lb	Nylon or EverTex®
16" x 24" - 2 Grommets, 2 rows of lock stitching on the fly-end		FLG1030		FLG1035	16"	24"	-	-	-	0.25 lb	Nylon or EverTex®
2' x 3' - 2 Grommets, 4 rows of lock stitching on the fly-end		FLG1040		FLG1045	24"	36"	-	-	-	0.25 lb	Nylon or EverTex®
2.5' x 4' - 2 Grommets, 4 rows of lock stitching on the fly-end		FLG1050		FLG1055	30"	48"	-	-	-	0.40 lb	Nylon or EverTex®
3' x 5' - 2 Grommets, 4 rows of lock stitching on the fly-end		FLG1060		FLG1065	36"	60"	-	-	-	0.50 lb	Nylon or EverTex®
4' x 6' - 2 Grommets, 4 rows of lock stitching on the fly-end		FLG1070		FLG1075	48"	72"	-	-	-	0.70 lb	Nylon or EverTex®
5' x 8' - 2 Grommets, 4 rows of lock stitching on the fly-end		FLG1080		FLG1085	60"	96"	-	-	-	1 lb	Nylon or EverTex®
6' x 10' - 2 Grommets, 4 rows of lock stitching on the fly-end		FLG1090		FLG1095	72"	120"	-	-	-	1.60 lbs	Nylon or EverTex®
8' x 12' - Rope & Thimble, 4 rows of lock stitching on the fly-end		FLG1100		FLG1105	96"	144"	-	-	-	2.90 lbs	Nylon or EverTex®
10' x 15' - Rope & Thimble, 1 grommet 4 rows of lock stitching on the fly-end		FLG1110		FLG1115	120"	180"	-	-	-	4.60 lbs	Nylon or EverTex®
12' x 18' - Rope & Thimble, 1 grommet 4 rows of lock stitching on the fly-end		FLG1120		FLG1125	144"	216"	-	-	-	6.50 lbs	Nylon or EverTex®
15' x 25' - Rope & Thimble, 3 grommets 4 rows of lock stitching on the fly-end		FLG1130		FLG1135	180"	300"	-	-	-	13.25 lbs	Nylon or EverTex®
20' x 30' - Rope & Thimble, 5 grommets 8 rows of lock stitching, + ZigZag		FLG1140		FLG1145	240"	360"	-	-	-	21 lbs	Nylon or EverTex®
20' x 38' - Rope & Thimble, 5 grommets 8 rows of lock stitching, + ZigZag		FLG1170		FLG1175	240"	456"	-	-	-	26.6 lbs	Nylon or EverTex®
25' x 40' - Rope & Thimble, 5 grommets 8 rows of lock stitching, + ZigZag		FLG1180		FLG1185	300"	480"	-	-	-	35 lbs	Nylon or EverTex®
30' x 50' - Rope & Thimble, 6 grommets 8 rows of lock stitching, + ZigZag		FLG1150		FLG1155	360"	600"	-	-	-	52.5 lbs	Nylon or EverTex®
30' x 60' - Rope & Thimble, 6 grommets 8 rows of lock stitching, + ZigZag		FLG1160		FLG1165	360"	720"	-	-	-	63 lbs	Nylon or EverTex®

*Single Reverse weight listed. **Double (x2)** the Single Reverse flag weight for double sided flag weight.



BRIGHT AND
BRILLIANT
COLORED
CUSTOM FLAGS

SHAPES & CONSTRUCTION

SINGLE REVERSE V. DOUBLE SIDED



FRONT



FRONT



BACK



BACK

Single Reverse prints have a 90% penetration rate and show the reverse image of the front side.

Double Sided prints can have two different designs on each side and have a liner sewn in between to keep images from meshing with each other.

FINISHING STYLES: 4 SHAPES TO CHOOSE FROM



STANDARD

The oldest and most used form of advertising for promotion.



GUIDON

Usually used in promoting military units in all of the branches.



BURGEE

Typically made for signaling and identifying boats and yachts.



PENNANT

Most often used for identifying teams & champions of all sports.

CUSTOM SHAPES

We pride ourselves in our ability to create anything you can dream of...so when it comes to custom shapes or additions, such as fringes, frays or anything else, we believe we can do it better and faster than anyone else. Additional fees may be added on depending on the time and additional materials needed. Please contact your sales representative for further details and we will get back to you asap.

EURO FLAG

EURO AD FLAG

Our Euro Ad Flags allow traditional flag poles to be transformed into a beautiful advertising media display. Based on a popular form of advertisement in Europe, we have developed a process to mount a vertical banner on a traditional flag pole with slight modifications. Each flag contains pole pockets to hold the pole hardware. Simply insert the vertical pole and horizontal pole into the pole pockets and add rope retainer rings every 4' to 5'. Weights are optional accessories to add to the bottom of the flag. The flag will fly perfectly and provide highly visible advertising.

SR = Single Reverse Flag

DS = Double Sided Flag

DESCRIPTION	SR	ITEM#	DS	ITEM#	GRAPHIC HEIGHT	GRAPHIC WIDTH	TOTAL HEIGHT	TOTAL WIDTH	TOTAL DEPTH	WEIGHT	MATERIAL
3' x 10'		FLT4600		FLT4695	120"	36"	-	-	-	0.25 lb	Nylon or EverTex®
3' x 15'		FLT4605		FLT4700	180"	36"	-	-	-	0.25 lb	Nylon or EverTex®
3' x 20'		FLT4610		FLT4705	240"	36"	-	-	-	0.25 lb	Nylon or EverTex®
3.5' x 10'		FLT4615		FLT4710	120"	42"	-	-	-	0.25 lb	Nylon or EverTex®
3.5' x 15'		FLT4620		FLT4715	180"	42"	-	-	-	0.40 lb	Nylon or EverTex®
3.5' x 20'		FLT4625		FLT4720	240"	42"	-	-	-	0.50 lb	Nylon or EverTex®
3.5' x 25'		FLT4630		FLT4725	300"	42"	-	-	-	0.70 lb	Nylon or EverTex®
4' x 15'		FLT4635		FLT4730	180"	48"	-	-	-	1 lb	Nylon or EverTex®
4' x 20'		FLT4640		FLT4735	240"	48"	-	-	-	1.60 lbs	Nylon or EverTex®
4' x 25'		FLT4645		FLT4740	300"	48"	-	-	-	2.90 lbs	Nylon or EverTex®

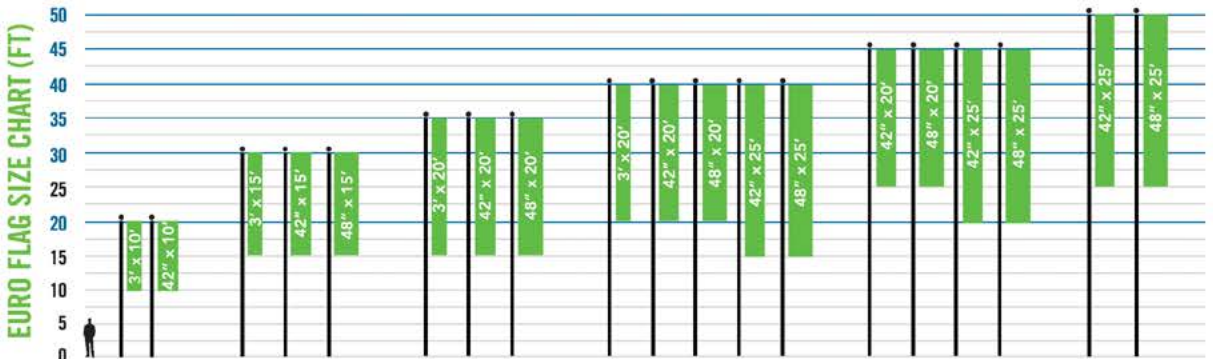

HOW IT WORKS

STEP 1

Flags are sewn with pole sleeves for housing display hardware.

POLE SLEEVES SEWN CLOSED

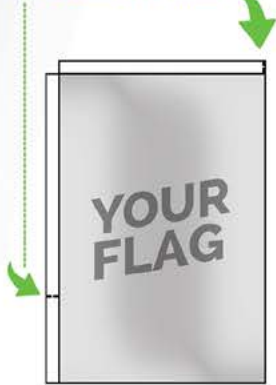

STEP 2

Hardware inserts into pole sleeve before installation

INSERT VERTICAL BAR POLE IN VERTICAL SLEEVE



STEP 3

Flag pole clip attaches to top of pole hardware, as flag is hoisted.

INSERT HORIZONTAL BAR POLE IN HORIZONTAL SLEEVE & ATTACH TO VERTICAL BAR POLE



STEP 4

Attach rings to flag, and fasten base weight at the bottom.

ATTACH TOP SLEEVE GROMMET TO FLAG POLE HALYARD. THEN HANG RETAINING RINGS AROUND POLE. FASTEN POLE WEIGHT AND HOIST FLAG.



HARDWARE COMPONENTS

Select 1 piece from each colored section below to build your hardware needed for your Euro Flag.

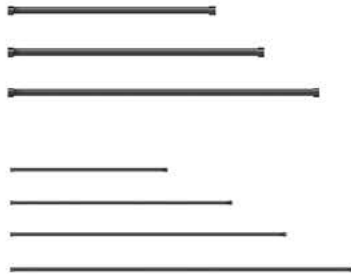

DESCRIPTION	ITEM#	TOTAL HEIGHT	TOTAL WIDTH	TOTAL DEPTH	WEIGHT	MATERIAL
3' Horizontal Top Bar	FLT4660	-	36"	0.5" Pole Diameter	0.25 lb	Fiberglass
3.5' Horizontal Top Bar	FLT4665	-	42"	0.5" Pole Diameter	0.25 lb	Fiberglass
4' Horizontal Top Bar	FLT4670	-	48"	0.5" Pole Diameter	0.25 lb	Fiberglass



Pole for 10' Vertical Flag	FLT4675	42"	-	0.5" Pole Diameter	0.40 lb	Fiberglass
Pole for 15' Vertical Flag	FLT4680	42"	-	0.5" Pole Diameter	0.50 lb	Fiberglass
Pole for 20' Vertical Flag	FLT4685	48"	-	0.5" Pole Diameter	0.70 lb	Fiberglass
Pole for 25' Vertical Flag	FLT4690	60"	-	0.5" Pole Diameter	1 lb	Fiberglass



8" Premium Ring	HDW2350	8"	1" Bead Diameter	-	0.75 lb	Stainless Steel Cable
12" Premium Ring	HDW2355	12"	1" Bead Diameter	-	1.2 lbs	Stainless Steel Cable
8" Economy Ring	HDW2340	8"	0.1875 Diameter	-	0.32 lb	Nylon Wire
12" Economy Ring	HDW2345	12"	0.1875 Diameter	-	0.36 lb	Nylon Wire



Weight	HDW2365	3.5"	2"	-	3.5 lbs	Plastisol Coated Steel
--------	---------	------	----	---	---------	------------------------

Quick Links	HDW2360	3"	1.37"	-	0.2 lbs	Stainless Steel
-------------	---------	----	-------	---	---------	-----------------

SPECIALTY FLAGS

TEARDROP SUCTION CUP FLAG

Place your marketing message front and center with our Teardrop Suction Cup Flag. These durable and adjustable position display flags have a suction cup as a base and easily adhere to smooth surfaces such as glass, appliances, painted wood, and car windows.



EASILY ADHERES TO SMOOTH SURFACES

BASE STAFF SWIVELS 45° TO GIVE YOU MULTIPLE DISPLAY OPTIONS.

SR = Single Reverse Flag

DS = Double Sided Flag

DESCRIPTION	SR	ITEM#	DS	ITEM#	GRAPHIC HEIGHT	GRAPHIC WIDTH	TOTAL HEIGHT	TOTAL WIDTH	TOTAL DEPTH	WEIGHT	MATERIAL
Hardware		DSP1225	-	-	-	-	38" w/ base	0.125" Diameter Pole	-	0.5 lb	Fiberglass & Plastic
Teardrop Print		SPF1165		SPF1170	21"	13"	-	-	-	0.3 lb / 0.6 lb	Nylon or EverTex®

TEARDROP CAR FLAG

The Teardrop Car Flags are best used on auto dealership lots, for conveying a simple advertising message that is highly visible. The structure of the pole displays the advertising message without needing wind. These products are for display only, and not to be used while driving.

*** FLAG NOT INTENDED FOR USE WHILE DRIVING**



SR = Single Reverse Flag

DS = Double Sided Flag

DESCRIPTION	SR	ITEM#	DS	ITEM#	GRAPHIC HEIGHT	GRAPHIC WIDTH	TOTAL HEIGHT	TOTAL WIDTH	TOTAL DEPTH	WEIGHT	MATERIAL
Hardware		FLT4410	-	-	-	-	42" w/ base	0.125" Diameter Pole	-	0.5 lb	Fiberglass
Teardrop Print		SPF1210		SPF1215	22"	15"	-	-	-	0.3 lb / 0.6 lb	Nylon or EverTex®



MINI TEARDROP CLIP FLAG

Our Mini Teardrop Clip Flag is digitally printed and perfect for advertising when on the go. Incredibly useful for in-aisle sale promotions, as warehouse labeling/safety markers, or clipped on to railings, cubicles, and POP displays. They're lightweight, easy to transport, and setup...it only takes seconds!

SR = Single Reverse Flag **DS** = Double Sided Flag

DESCRIPTION	SR	ITEM#	DS	ITEM#	GRAPHIC HEIGHT	GRAPHIC WIDTH	TOTAL HEIGHT	TOTAL WIDTH	TOTAL DEPTH	WEIGHT	MATERIAL
Hardware		DSP1445	-	-	-	-	40" w/ clip	0.125" Diameter Pole	-	0.5 lb	Metal/Plastic
Teardrop Print		SPF1220		SPF1225	20"	15"	-	-	-	0.25 lb / 0.5 lb	Nylon or EverTex®



TABLE TEARDROP FLAG

The Table Teardrop Flag, aka the custom desk flag, is perfect for conferences, meetings, trade shows or even just as a great decoration on your home office desk. You can have any custom logo, crest, mascot, branding or custom image printed onto this beautiful table flag.

SR = Single Reverse Flag **DS** = Double Sided Flag

DESCRIPTION	SR	ITEM#	DS	ITEM#	GRAPHIC HEIGHT	GRAPHIC WIDTH	TOTAL HEIGHT	TOTAL WIDTH	TOTAL DEPTH	WEIGHT	MATERIAL
Hardware		DSP1445	-	-	-	-	33" w/ base	0.125" Diameter Pole	-	1lb	Fiberglass/Metal
Teardrop Print		SPF1230		SPF1235	19"	12"	-	-	-	0.5 lb / 1lb	Nylon or EverTex®



BACKPACK FLAG

The comfortable BackPack Flag kit is available with a single or double-sided printed flag. Each specific pole kit provides the ability to fully view your custom printed message when there is no wind. Towering high above you, this back carrying flag kit is sure to create interest and gain attention when used at any event.

*** BACK PACK STORES FLAG & ACCESSORIES**

SR = Single Reverse Flag **DS** = Double Sided Flag



DESCRIPTION	SR	ITEM#	DS	ITEM#	GRAPHIC HEIGHT	GRAPHIC WIDTH	TOTAL HEIGHT	TOTAL WIDTH	TOTAL DEPTH	WEIGHT	MATERIAL
Teardrop Print		SPF1240		SPF1245	44.75"	16.5"	-	-	-	1.5 lbs / 3 lbs	Nylon or EverTex®
Blade Print		SPF1300		SPF1305	47.75"	16.5"	-	-	-	1.5 lbs / 3 lbs	Nylon or EverTex®
Premium 90 Print		SPF1310		SPF1315	49.75"	16"	-	-	-	1.5 lbs / 3 lbs	Nylon or EverTex®
BackPack & Hardware		DSP1480	-	-	-	-	72"	12"	3.5"	3 lbs	Meta/Polyester

FLAGS

GOLF & STICK



GOLF FLAG

Golf flags are digitally printed with deep vibrant colors and can be produced on a golf tube or finished with a canvas header and grommets.

SR – Single Reverse Flag

DS – Double Sided Flag

DESCRIPTION	SR	ITEM#	DS	ITEM#	GRAPHIC HEIGHT	GRAPHIC WIDTH	TOTAL HEIGHT	TOTAL WIDTH	TOTAL DEPTH	WEIGHT	MATERIAL
Golf Flag with Canvas Header and Grommets		SPF1050		SPF1055	14"	20"	-	-	-	0.25 lb	Textile
Golf Flag w/Tube		SPF1060		SPF1065	14"	20"	-	-	-	0.25 lb	Textile

*Single Reverse weight listed. **Double (x2)** the Single Reverse flag weight for double sided flag weight.

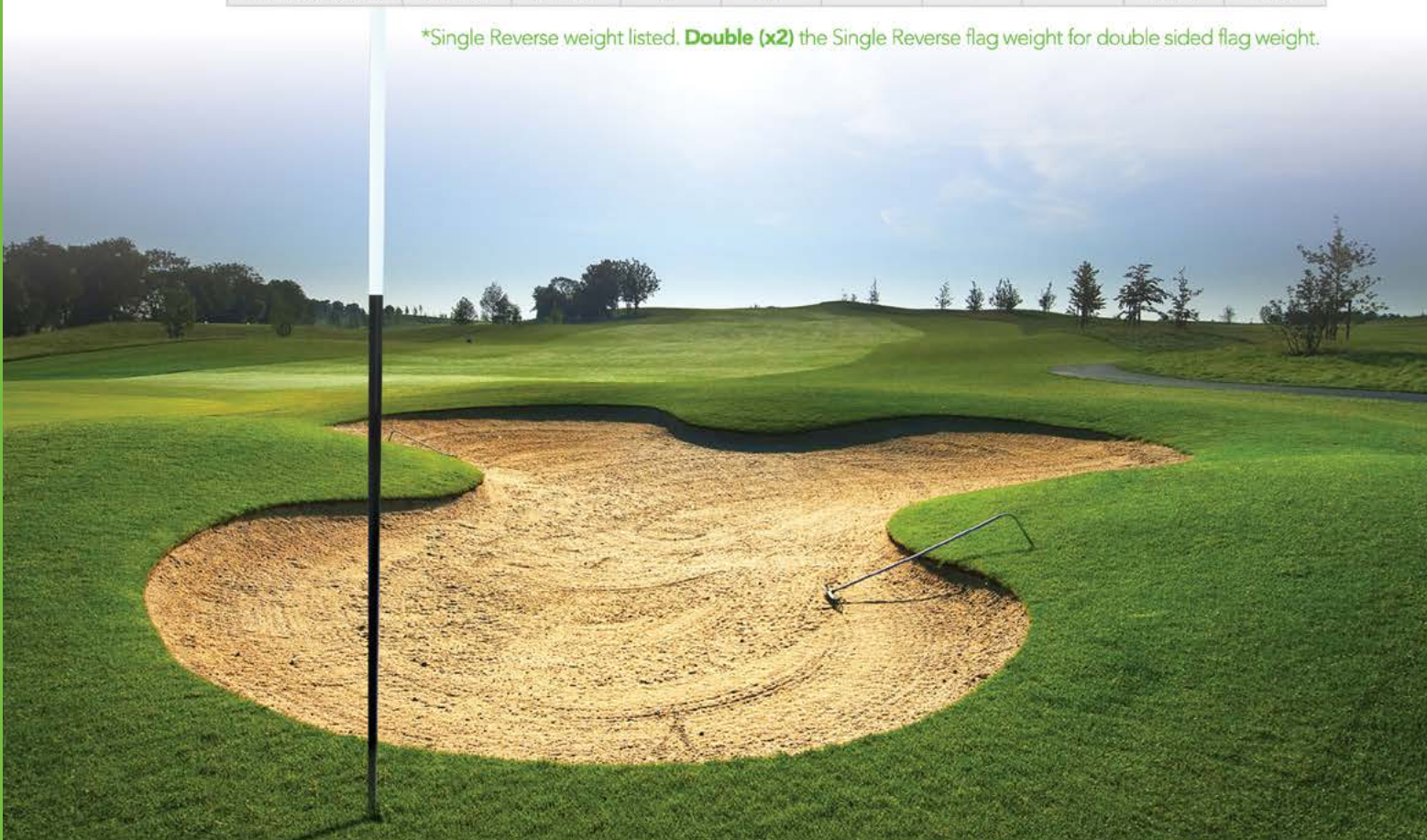



↑
COMES IN
DIFFERENT
SIZES &
GOLD TIPS

STICK FLAGS

These beautiful stick flags are printed in vibrant colors and are finished on appropriate sized staff. Finished with a clean protective edge, to prevent material from fraying, these stick flags will leave you waving your flag long after your event is over.

SR = Single Reverse Flag

DS = Double Sided Flag

DESCRIPTION	ITEM#	GRAPHIC HEIGHT	GRAPHIC WIDTH	TOTAL HEIGHT	TOTAL WIDTH	TOTAL DEPTH	WEIGHT	MATERIAL
4" x 6"	SPF1010	6"	4"	-	6"	-	0.15 lb	Textile
6" x 9"	SPF1015	9"	6"	-	9"	-	0.15 lb	Textile
8" x 12"	SPF1020	12"	8"	-	12"	-	0.15 lb	Textile
12" x 18"	SPF1025	18"	12"	-	18"	-	0.15 lb	Textile
16" x 24"	SPF1030	24"	16"	-	24"	-	0.15 lb	Textile
24" x 36"	SPF1140	36"	24"	-	36"	-	0.15 lb	Textile



BANNER

SPIRIT FLAG & TEAR-AWAY



POLE
KIT
COMES
WITH
TELESCOPING
POLES



TEAR-AWAY / RUN-THROUGH BANNER

Get the crowd going with a grand entrance! Tear-Away Banners are perfect for your team's next sporting event. Made to break through, this high quality banner is the perfect pre, post or half-time game accessory to show off your team spirit. Once used, reattach it to hang on the side line and then use for photos after the game. Tear-away banners are not just fun, they re-enforce team spirit and may give you that once-in-a-lifetime photo.

HIGHLIGHTS

- ✓ Fastened with Velcro®
- ✓ Break it apart & put it back together again
- ✓ Resists wear & tear
- ✓ Show your team pride by creating a custom design
- ✓ Very strong and durable

DESCRIPTION	ITEM#	TOTAL HEIGHT	TOTAL WIDTH	TOTAL DEPTH	WEIGHT	MATERIAL
6' x 10' Print	SPF1250	74"	127"	-	2 lbs	Textile or Vinyl
8' x 12' Print	SPF1255	100"	148"	-	2.5 lbs	Textile or Vinyl
10' x 15' Print	SPF1260	124"	186"	-	3.5 lbs	Textile or Vinyl
15' Telescoping Pole Set	SPF1295	185.5"	1.5"	1.5"	4 lbs each	Fiberglass

TEAR-AWAY BANNER Illustration CONSTRUCTION

Let your customer service representative know which style you would like your Tear-Away banner.

STYLE A

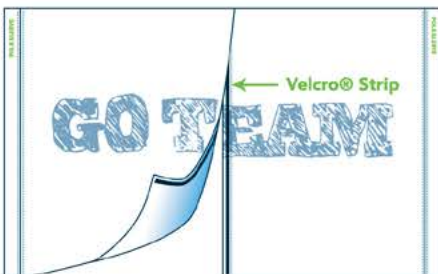

STYLE B

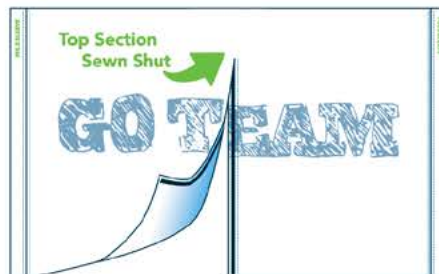

STYLE C

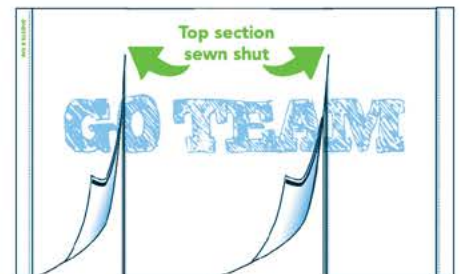



SPIRIT FLAG

The Spirit Flag is one of the best ways to get your crowd electrified with excitement. Have your flag digitally printed with your team mascot or name. Flag sizes start at 3' x 5' and go all the way up to 8' x 12'.

SR = Single Reverse Flag

DS = Double Sided Flag

DESCRIPTION	SR	ITEM#	DS	ITEM#	GRAPHIC HEIGHT	GRAPHIC WIDTH	TOTAL HEIGHT	TOTAL WIDTH	TOTAL DEPTH	WEIGHT	MATERIAL
3' x 5' Flag		FLG1270		FLG1295	36"	60"	-	-	-	0.45 lb	Nylon or EverTex®
4' x 6' Flag		FLG1275		FLG1300	48"	72"	-	-	-	0.7 lb	Nylon or EverTex®
5' x 8' Flag		FLG1280		FLG1305	60"	96"	-	-	-	1 lb	Nylon or EverTex®
6' x 10' Flag		FLG1285		FLG1310	72"	120"	-	-	-	1.6 lbs	Nylon or EverTex®
8' x 12' Flag		FLG1290		FLG1315	96"	144"	-	-	-	2.9 lbs	Nylon or EverTex®

15' Telescoping Pole		FLT1575		-	-	-	185.5"	1.5"	1.5"	4 lbs	Fiberglass
----------------------	--	---------	--	---	---	---	--------	------	------	-------	------------

* POLE MUST BE BOUGHT SEPARATELY

*Single Reverse weight listed. **Double (x2)** the Single Reverse flag weight for double sided flag weight.

FLAGS

CAR & EVENT



CAR FLAGS

STANDARD CAR FLAG

Our standard car flags are produced on durable, knitted polyester and can be finished as single reverse or double sided.

Car flag hardware is included.

SR = Single Reverse Flag **DS** = Double Sided Flag

DESCRIPTION	SR	ITEM#	DS	ITEM#	GRAPHIC HEIGHT	GRAPHIC WIDTH	TOTAL HEIGHT	TOTAL WIDTH	TOTAL DEPTH	WEIGHT	MATERIAL
Flag Print & Tube Kit		SPF1035		SPF1040	12"	18"	20"	18"	-	0.5 lb / 1 lb	Textile Flag & Plastic Tube



TAILGATING FLAG, POLE & BASE

This flag pole is portable, lightweight and adjustable. It comes with a cam-locking action that allows each section to lock in place, so it will not collapse when extended. Simply rotate tube to lock or unlock.

Perfect for use at stadium events, tailgate parties, parades, picnics, graduations and camp sites.



SR = Single Reverse Flag **DS** = Double Sided Flag

DESCRIPTION	SR	ITEM#	DS	ITEM#	GRAPHIC HEIGHT	GRAPHIC WIDTH	TOTAL HEIGHT	TOTAL WIDTH	TOTAL DEPTH	WEIGHT	MATERIAL
Hardware		SPF1280		-	-	-	238"	18"	2.25" Diameter Pole	11.5 lbs	Plastic & Aluminum



5M POLE & FLAG

The 5M transportable advertising flag pole converts any common, hard surface into a grand advertising arena. This product works indoors or outdoors, and will catch everyone's attention.



SR = Single Reverse Flag **DS** = Double Sided Flag

DESCRIPTION	SR	ITEM#	DS	ITEM#	GRAPHIC HEIGHT	GRAPHIC WIDTH	TOTAL HEIGHT	TOTAL WIDTH	TOTAL DEPTH	WEIGHT	MATERIAL
Flag Print		FLT1610	-		138"	42"	-	-	-	3 lbs / 6 lbs	Nylon or EverTex®
Hardware & Bag		FLT1615	-		-	-	Pole 209" Water Base 5"	Pole Extends 49" Water Base 32"	Pole Diameter 2.25" Water Base 32"	29 lbs without water	Plastic & Aluminum



PROMO POLE & FLAG

This product creates a simple and affordable advertising solution for indoor or outdoor use. Water base holds up to 20 lbs water.



SR = Single Reverse Flag **DS** = Double Sided Flag

DESCRIPTION	SR	ITEM#	DS	ITEM#	GRAPHIC HEIGHT	GRAPHIC WIDTH	TOTAL HEIGHT	TOTAL WIDTH	TOTAL DEPTH	WEIGHT	MATERIAL
Flag Print		FLT2760	-		96"	30"	-	-	-	1 lb / 2 lbs	Nylon or EverTex®
Hardware Kit		FLT2555	-		-	-	Pole Extends 96" 7" Base	Pole Extends 36" 14" Base	1" Pole 14" Base	1.5 lb No Water 20 lbs with Water	Plastic

FLAGS

SPECIALTY



HIGHLIGHTS

- ✓ Easily change a flag out for every season!
- ✓ Digitally printed graphics on high quality textiles
- ✓ Promote a campaign, team or season in style!
- ✓ Single reverse or double sided prints available
- ✓ Durable, lightweight aluminum frame perfect for all seasons

GARDEN FLAG

Garden flags are produced on durable, knitted polyester. The material is loose knit and hangs cleanly on the garden pole. This allows your custom design to stand out in your front yard or garden. It can also be used for basic advertising. In addition to our standard design, we now offer a 60" Garden Blade Flag.

SR = Single Reverse Flag **DS** = Double Sided Flag

DESCRIPTION	SR	ITEM#	DS	ITEM#	GRAPHIC HEIGHT	GRAPHIC WIDTH	TOTAL HEIGHT	TOTAL WIDTH	TOTAL DEPTH	WEIGHT	MATERIAL
12" x 18" Garden Flag		SPF1070		SPF1080	18"	12"	-	-	-	0.25 lb / 0.5 lbs	Nylon or EverTex®
Standard Hardware		SPF1085		-	-	-	30.5"	16"	0.25"	1 lb	Metal
18" x 24" Garden Flag		SPF1320		SPF1325	24"	18"	-	-	-	0.25 lb / 0.5 lbs	Nylon or EverTex®
Standard Hardware		SPF1085		-	-	-	30.5"	16"	0.25"	1 lb	Metal
36" x 48" Garden Flag		SPF1270		SPF1275	48"	36"	-	-	-	0.25 lb / 0.5 lbs	Nylon or EverTex®
3-Piece Hardware		SPF1265		-	-	-	63"	34.5"	0.3"	5 lbs	Metal
Garden Blade Flag		SPF1180		SPF1185	60"	16.5"	-	-	-	1.5 lbs / 3 lbs	Nylon or EverTex®
Standard Xtra Small Pole Kit		FLT4300		-	-	-	75"	0.25"	0.25"	0.5 lbs	Fiberglass, Polyester Bag & Steel



HOUSE POLE KITS SPINNER POLE KIT

Our basic white spinner pole is made of fiberglass and comes with a built-in ball-bearing spinner and a multi-angle mounting bracket.

Mounted Flags can be finished with a pole sleeve or canvas header & grommets.

Suggested Flag Sizes: 2.5' x 4', 3' x 5', 4' x 6' (Max Size)

DESCRIPTION	ITEM#	TOTAL HEIGHT	TOTAL WIDTH	TOTAL DEPTH	WEIGHT	MATERIAL
Spinner Kit	HDW1005	72"	1"	1"	2 lbs	Aluminum



20' HOMESTEADER FLAG POLE KIT

Our 20' aluminum home pole kit is made for the traditional flag pole display. The 5 piece sectional pole kit allows for easy installation and display around homes and businesses. It is recommended not to exceed a 4'x6' flag on this pole kit.

DESCRIPTION	ITEM#	TOTAL HEIGHT	TOTAL WIDTH	TOTAL DEPTH	WEIGHT	MATERIAL
Home Flag Pole	HDW1010	258"	2"	2"	9.5 lbs	Aluminum

GARDEN FLAG

LOLLIPOP



LOLLIPOP POLES & SIGN TOPPERS

Needing a versatile, beautiful display system that will catch the attention of your customers and guests?

Look no further!!! These custom printed Lollipop displays are a stand-out piece that will get you the attention you want in any outdoor promotional event.

Available Sign Topper Sizes:
30", 24" and 18" in diameter



HARDWARE KIT



LOLLIPOP RING



POLE



SPIKE

SS = Single Single Print

DS = Double Sided Print

DESCRIPTION	SS	ITEM#	DS	ITEM#	GRAPHIC HEIGHT	GRAPHIC WIDTH	TOTAL HEIGHT	TOTAL WIDTH	TOTAL DEPTH	WEIGHT	MATERIAL
18" Diameter Print		OAD0005		OAD0010	18"	18"	-	-	-	0.25 lb	Textile
24" Diameter Print		OAD0015		OAD0020	24"	24"	-	-	-	0.25 lb	Textile
30" Diameter Print		OAD0025		OAD0030	30"	30"	-	-	-	0.25 lb	Textile
Adjustable Ring		HUM1055	-	-	-	-	18", 24" & 36" Diameter	1"	-	1 - 3 lbs	Plastic
"The One" Vertical Adjustable Pole		DSP1695	-	-	-	-	38", 48" & 60"	0.5" Diameter	-	1 - 2 lbs	Fiberglass
Spike		DSP1710	-	-	-	-	24"	0.5"	0.5"	2 lbs	Steel

*Single Reverse weight listed. **Double (x2)** the Single Reverse flag weight for double sided flag weight.

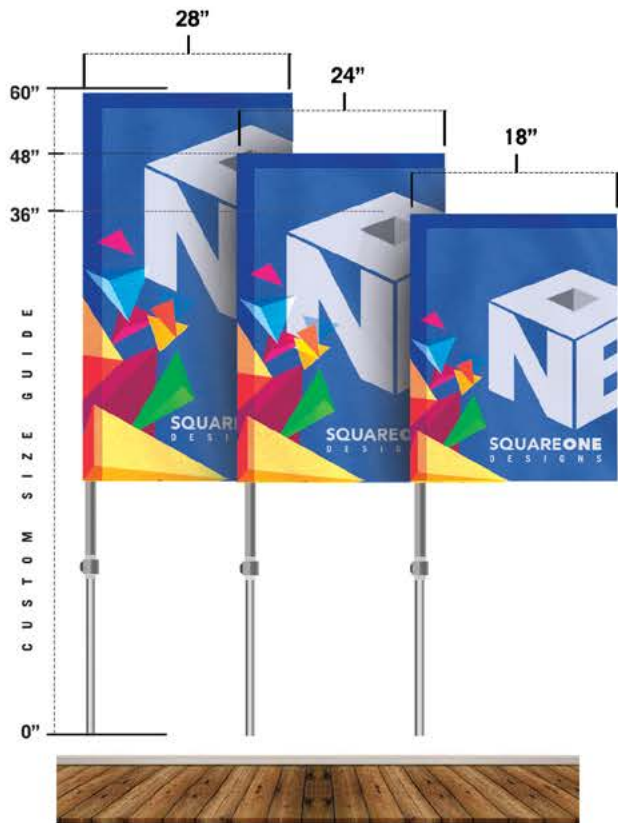

PRINT OPTIONS

Single Reverse



Double Sided



HARDWARE KIT

KIT INCLUDES:
POLE, SPIKE & CLEVIS PIN

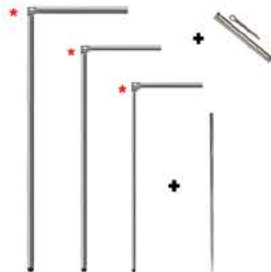

Only 1 Pole Set* is sent per kit

WATER BASE



Water base stabilizes your custom lollipop flag in any indoor and outdoor locations.



THE DRIVE-THRU DISPLAY

Perfect for capturing the attention of customers as they drive-thru small one-way pathways. This display will assemble in minutes and instantly become a strong promotional selling point for frequent combos and company deals that you may offer.

Talk to your customer service representative for desired size needed.

Available Sizes: 28" x 60", 24" x 48" and 18" x 36"

SS = Single Sided Print

DS = Double Sided Print

DESCRIPTION	SS	ITEM#	DS	ITEM#	GRAPHIC HEIGHT	GRAPHIC WIDTH	TOTAL HEIGHT	TOTAL WIDTH	TOTAL DEPTH	WEIGHT	MATERIAL
18" x 36" Print		OAD0035		OAD0040	36"	18"	-	-	-	0.25 lbs	Textile
24" x 48" Print		OAD0045		OAD0050	48"	24"	-	-	-	0.5 lbs	Textile
28" x 60" Print		OAD0055		OAD0060	60"	28"	-	-	-	1 lbs	Textile
Water Base		DSP1705		-	-	-	16"	16"	8"	6 lbs	Plastic
*The One" Horizontal Adjustable Pole		DSP1700		-	-	-	0.5" Diameter	18", 24" & 28"	-	1 - 2 lbs	Fiberglass
*The One" Vertical Adjustable Pole		DSP1695		-	-	-	38", 48" & 60"	0.5" Diameter	-	1 - 3 lbs	Fiberglass
Spike		DSP1710		-	-	-	24"	0.5"	0.5"	2 lbs	Steel

*Single Reverse weight listed. **Double (x2)** the Single Reverse flag weight for double sided flag weight.

TAUT N' TIGHT SPIKE



BUNGEE CORDS COME WITH POLES



POLE MEASURES 50" IN LENGTH



STAINLESS STEEL SPIKE



TAUT N' TIGHT BANNER SPIKE

The Taut n' Tight banner spike is the perfect compliment to your banner! The ideal tool to help keep your banner from sagging. The Taut n' Tight pole spike is made of fiberglass and comes with a metal loop & bungee on top to securely keep your banner taut and tight. **Max Banner Size Capability: 4' x 6'**

* Each pole is sold separately

DESCRIPTION	ITEM#	TOTAL HEIGHT	TOTAL WIDTH	TOTAL DEPTH	WEIGHT	MATERIAL
Pole, Bag & Spike Set	DSP1580	50"	2 pole installation width dependent on banner size	0.5"	3 lbs	Fiberglass & Steel



DOOR FRAME DISPLAY & PRINT

Designed to keep banners open and legible, our Door Frame Display uses interlocking metal poles to keep your pillowcase printed banner firmly taut and legible.

Hardware comes with:

2 Poles, 2 Spikes & 1 Center Connecting Pole



SS = Single Sided Print

DS = Double Sided Print

DESCRIPTION	SS	ITEM#	DS	ITEM#	GRAPHIC HEIGHT	GRAPHIC WIDTH	TOTAL HEIGHT	TOTAL WIDTH	TOTAL DEPTH	WEIGHT	MATERIAL
5' x 5' Pillowcase Print		OAD1150		OAD1155	60"	60"	-	-	-	1.5 lbs	Soft Knit
Hardware		DSP1150		-	-	-	72"	72"	1"	2.5 lbs	Fiberglass & Steel

A-FRAMES STREET DISPLAY

A-FRAMES STEEL A-FRAMES

Our new weather-resistant and sturdy Steel A-Frames are a must-have for busy streets. Graphics are easily interchangeable by snapping into built-in rails.

A variety of graphic print materials and sizes are available.

DISPLAYS CAN HOLD

2 PRINTS



SS = Single Sided Print **DS** = Double Sided Print

DESCRIPTION	SS	ITEM#	DS	ITEM#	GRAPHIC HEIGHT	GRAPHIC WIDTH	TOTAL HEIGHT	TOTAL WIDTH	TOTAL DEPTH	WEIGHT	MATERIAL
Style 1		AFR1100	-	-	-	-	26.5"	24.5"	31"	11 lbs	Steel
Print		AFR1165	-	-	18"	24"	-	-	-	1 lb	Adhesive, Coroplast, or Paper

DESCRIPTION	SS	ITEM#	DS	ITEM#	GRAPHIC HEIGHT	GRAPHIC WIDTH	TOTAL HEIGHT	TOTAL WIDTH	TOTAL DEPTH	WEIGHT	MATERIAL
Style 2		AFR1125	-	-	-	-	36.5"	26.5"	21"	12.5 lbs	Steel
Print		AFR1170	-	-	36"	24"	-	-	-	1 lb	Adhesive, Coroplast, or Paper

DESCRIPTION	SS	ITEM#	DS	ITEM#	GRAPHIC HEIGHT	GRAPHIC WIDTH	TOTAL HEIGHT	TOTAL WIDTH	TOTAL DEPTH	WEIGHT	MATERIAL
Style 3		AFR1095	-	-	-	-	26.5"	36.5"	30"	12.5 lbs	Steel
Print		AFR1175	-	-	24"	36"	-	-	-	1 lb	Adhesive, Coroplast, or Paper

Front View



Side View



ALUMINUM A-FRAME

Our Aluminum A-Frame is double sided and comes with a protective acrylic film that protects the graphic from light weather conditions. Print can be produced on adhesive, coroplast, or paper.

SS = Single Sided Print

DS = Double Sided Print

DESCRIPTION	SS	ITEM#	DS	ITEM#	GRAPHIC HEIGHT	GRAPHIC WIDTH	TOTAL HEIGHT	TOTAL WIDTH	TOTAL DEPTH	WEIGHT	MATERIAL
Hardware		AFR1025		-	-	-	55"	30"	27"	16 lbs	Aluminum
Print		AFR1020		-	44"	28"	-	-	-	1 lb	Adhesive, Coroplast, or Paper

STREET DISPLAYS

DISPLAY CAN HOLD
2 PRINTS



Reverse Side View

Different print shown for double sided versatility



Base fills up with 7 gallons of water, and adds up to 65 lbs of weight to keep your base in place and stabilized.



EASY SNAP CLIPS TO HOLD PRINT



CASTER WHEELS FOR EASY TRANSPORT

SIDEWALK SIGN

The Sidewalk Sign has a rugged steel spring system that sits on a tough, fillable plastic water base with easy-to-transport caster wheels. This display system will hold up in all types of weather conditions. Graphics are easily interchangeable with its 4 sided snap-shut frame, plus a variety of graphic print materials are also available for use with it - including polystyrene, adhesive vinyl or paper.

Please note that while the snap frame and cover lens work to seal out moisture, your posters may become damaged if utilized in extremely harsh circumstances for example heavy rain and snowstorms.

SS = Single Sided Print

DS = Double Sided Print

DESCRIPTION	SS	ITEM#	DS	ITEM#	GRAPHIC HEIGHT	GRAPHIC WIDTH	TOTAL HEIGHT	TOTAL WIDTH	TOTAL DEPTH	WEIGHT	MATERIAL
Hardware		AFR1035	-	-	-	-	47"	25.5"	19"	28 lbs	Aluminum/Plastic
Print		AFR1030	-	-	33"	23.5"	-	-	-	1 lb	Adhesive, Coroplast, or Paper



DISPLAY CAN HOLD
2 PRINTS

EASY TO SET UP & SHARE PROMOTIONS WITH YOUR CUSTOMERS!

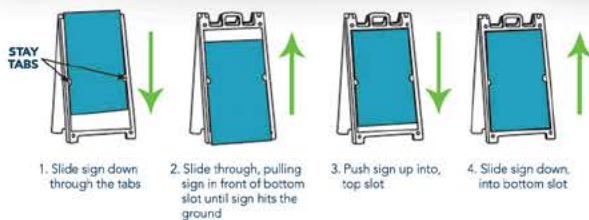

SIGNICADE® DELUXE

Perfect for any outdoor signage need, the Signicade® Deluxe is made of sturdy plastic and is easy to set up and tear down. It is produced exclusively from polyethylene, a rugged plastic, rendering them perfect for outdoor use. Known for its rugged construction, the frames won't rust or splinter over time.

The Signicade® Deluxe sidewalk sign is double-sided, and is engineered to accommodate two 24" x 36" sign inserts up to 3/16" in thickness.

SS – Single Sided Print

DS – Double Sided Print

DESCRIPTION	SS	ITEM#	DS	ITEM#	GRAPHIC HEIGHT	GRAPHIC WIDTH	TOTAL HEIGHT	TOTAL WIDTH	TOTAL DEPTH	WEIGHT	MATERIAL
Hardware		AFR1120	-	-	-	-	36"	27"	34.5"	20.5 lbs	Plastic
Print		AFR1160	-	-	35"	24"	-	-	0.1875" Max	1 lb	Adhesive, Coroplast, or Paper

TREK RETRACTOR



Spring Action Pole allows banner to flex in the windiest of conditions!



TREK RETRACTOR

The Trek Retractor is a great solution for outdoor advertising. This display has a spring-action pole that mounts on the heavy base, allowing for the display to bend in the the week. The sleek, silver stand can be used both indoors and outdoors. This two-sided display will easily increase visibility of any advertising message.

Travel bag included with hardware.

SS = Single Sided Print

DS = Double Sided Print

DESCRIPTION	SS	ITEM#	DS	ITEM#	GRAPHIC HEIGHT	GRAPHIC WIDTH	TOTAL HEIGHT	TOTAL WIDTH	TOTAL DEPTH	WEIGHT	MATERIAL
Hardware		DSP1485		-	-	-	82.25"	35.625"	32.25"	16 lbs	Aluminum
Print		DSP1620		-	78"	33.5"	-	-	-	1 lb	Adhesive, Coroplast, or Paper

ROLL N' GO

ROLL N' GO DISPLAY

Our portable Roll N' Go display accepts signs from 12" x 18" to 24" x 30". Used for safety, valet parking and sale notice signs, this display is versatile and easy to move. Printed signs can be added and removed in seconds. It can also be used with single mounted signs or 2-sided, back-to-back mounted signs. Stability plates keep the sign from twisting on the pole. The outdoor sign holder has a rust-proof, low-profile technopolymer base with a ballast port that can be filled with sand or water for extra stability in winds up to 30-40 mph. Portable pole outdoor sign can be easily moved from place to place—just grab the nylon loop handle, lean it over and then Roll n' Go.

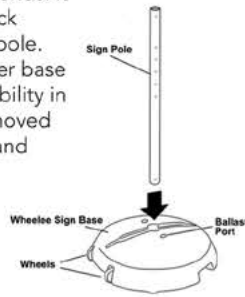

PORTABLE BASE HAS 2 DISPLAY OPTIONS:

- (a) Base, Print & Pole or
- (b) Base & Print

Sign board inserts securely into base and accommodates signs from 12" x 18" to 24" x 30"

SS = Single Sided Print DS = Double Sided Print

DESCRIPTION	SS	ITEM#	DS	ITEM#	GRAPHIC HEIGHT	GRAPHIC WIDTH	TOTAL HEIGHT	TOTAL WIDTH	TOTAL DEPTH	WEIGHT	MATERIAL
Hardware		OAD1140	-	-	-	-	50" with pole	24" Diameter Base	-	10.5 lbs	Aluminum Pole / Plastic Pole
Print		OAD1160	-	-	30" Max	24" Max	-	-	-	Varies	Styrene or Coroplast

REALTY SIGNS

REALTY SWING N' POST SIGN

All metal construction. Made in the USA! Heavy Gauge 1" Square tube. Sleek black powder coat finish. Two piece construction for easy set up. Threaded inserts for rider attachment.

Mounting hardware included.



SS = Single Sided Print

DS = Double Sided Print

DESCRIPTION	SS	ITEM#	DS	ITEM#	GRAPHIC HEIGHT	GRAPHIC WIDTH	TOTAL HEIGHT	TOTAL WIDTH	TOTAL DEPTH	WEIGHT	MATERIAL
Hardware		OAD0065		-	-	-	40"	27"	1"	5.5 lbs	Steel
16" x 36" Print		OAD0110		OAD0115	16"	36"	-	-	-	1 lb	Coroplast
6" x 24" Rider Print		OAD0070		OAD0075	6"	24"	-	-	-	1 lb	Coroplast

DOUBLE RIDER REALTY SIGN

Double Rider frames are made of solid 3/4" angle steel with rounded corners, pre-punched mounting slots and die cut loops for easy panel attachment. The pointed legs provide ease of ground insertion.

Frames come standard with a beautiful black powder coat finish.

HIGHLIGHTS

- ✓ 24" x 18" or 24" x 24" main panel with a 6" rider above and below
- ✓ 3/4" angle steel, black finish
- ✓ Holds up to 1/4" substrate
- ✓ Panels can easily slide in from the top or can be bolted in
- ✓ Overall height: 46"



SS = Single Sided Print

DS = Double Sided Print

DESCRIPTION	SS	ITEM#	DS	ITEM#	GRAPHIC HEIGHT	GRAPHIC WIDTH	TOTAL HEIGHT	TOTAL WIDTH	TOTAL DEPTH	WEIGHT	MATERIAL
18" x 24" Hardware		OAD1130	-	-	-	-	46"	25"	.75"	10 lbs	Steel
18" x 24" Print		OAD0080	OAD0085		18"	24"	-	-	-	1 lb	Coroplast
24" x 24" Hardware		OAD1135	-	-	-	-	46"	25"	.75"	10 lbs	Steel
24" x 24" Print		OAD0100	OAD0105		24"	24"	-	-	-	1 lb	Coroplast
6" x 24" Rider Print		OAD0070	OAD0075		6"	24"	-	-	-	1 lb	Coroplast



SINGLE RIDER REALTY SIGN

Single Rider frames are made of solid 3/4" angle steel with rounded corners, pre-punched mounting slots and die cut loops for easy panel attachment. The pointed legs provide ease of ground insertion.

Frames come standard with a beautiful black powder coat finish.

HIGHLIGHTS

- ✓ 24" x 18" or 24" x 24" main panel with a 6" single rider below
- ✓ 3/4" angle steel, black finish
- ✓ Holds up to 1/4" substrate
- ✓ Panels can easily slide in from the top or can be bolted in
- ✓ Overall height: 42"

SS = Single Sided Print

DS = Double Sided Print

DESCRIPTION	SS	ITEM#	DS	ITEM#	GRAPHIC HEIGHT	GRAPHIC WIDTH	TOTAL HEIGHT	TOTAL WIDTH	TOTAL DEPTH	WEIGHT	MATERIAL
18" x 24" Hardware		OAD1120	-	-	-	-	42"	24.5"	.75"	10 lbs	Steel
18" x 24" Print		OAD0080	OAD0085		18"	24"	-	-	-	1 lb	Coroplast
20" x 24" Hardware		OAD1125	-	-	-	-	42"	24.5"	.75"	10 lbs	Steel
20" x 24" Print		OAD0090	OAD0095		20"	24"	-	-	-	1 lb	Coroplast
6" x 24" Rider Print		OAD0070	OAD0075		6"	24"	-	-	-	1 lb	Coroplast

POP-UPS LIGHTWEIGHT

LIGHTWEIGHT SIGNS A-FRAME POP-UPS

Lightweight printed on pop-up sign that travels well and folds easily into an included storage bag.

- ✔ 100% Polyester with a steel frame
- ✔ 2-sided display
- ✔ Anchors down with included tent stakes



4 POP-UP STAKES

	DESCRIPTION	ITEM#	GRAPHIC HEIGHT	GRAPHIC WIDTH	TOTAL HEIGHT	TOTAL WIDTH	TOTAL DEPTH	WEIGHT	MATERIAL
1	Small Horizontal Pop-Up	HUM1105	28"	48"	28"	48"	16"	3 lbs	Soft Knit Wrapped on Steel Frame
	Medium Horizontal Pop-Up	HUM1110	36"	72"	36"	72"	24"	4 lbs	Soft Knit Wrapped on Steel Frame
	Large Horizontal Pop-Up	HUM1115	48"	100"	48"	100"	30"	6 lbs	Soft Knit Wrapped on Steel Frame
2	Small Vertical Pop-Up	HUM1165	36"	24"	36"	24"	16"	3 lbs	Soft Knit Wrapped on Steel Frame
	Medium Vertical Pop-Up	HUM1170	50"	36"	50"	36"	24"	4 lbs	Soft Knit Wrapped on Steel Frame
	Large Vertical Pop-Up	HUM1175	65"	44"	80"	44"	30"	5 lbs	Soft Knit Wrapped on Steel Frame
3	Small Circular Pop-Up	HUM1135	40"	40"	40"	40"	16"	3 lbs	Soft Knit Wrapped on Steel Frame
	Medium Circular Pop-Up	HUM1140	48"	48"	48"	48"	24"	4 lbs	Soft Knit Wrapped on Steel Frame
	Large Circular Pop-Up	HUM1145	60"	60"	60"	60"	30"	5 lbs	Soft Knit Wrapped on Steel Frame
4	Pop-Up Stakes	TNT1195	N/A	N/A	12"	8"	2"	2 lbs	Steel

HUMAN DIRECTIONAL

Portable, lightweight message boards are great advertising solutions. This sign provides the extra option of a custom message panel securely adhered with Velcro®. Typical message examples include daily specials, seasonal promotions, etc.

Made of 100% Polyester with thin steel frame. Includes storage bag and soft neck strap.



Changeable message attaches with Velcro®



DESCRIPTION	ITEM#	GRAPHIC HEIGHT	GRAPHIC WIDTH	TOTAL HEIGHT	TOTAL WIDTH	TOTAL DEPTH	WEIGHT	MATERIAL
48" x 28" Human Directional	HUM1190	28"	48"	-	-	-	2 lbs	Soft Knit Wrapped on Steel Frame
48" x 28" Directional with Velcro® Message	HUM1195	28" / 6"	48" / 36"	-	-	-	2.25 lbs	Soft Knit Wrapped on Steel Frame
48" Velcro® Message Strip	HUM1200	6"	36"	-	-	-	0.25 lb	Soft Knit with Velcro®
72" x 36" Human Directional	HUM1005	36"	72"	-	-	-	3 lbs	Soft Knit Wrapped on Steel Frame
72" x 36" Directional with Velcro® Message	HUM1010	36" / 6"	72" / 64"	-	-	-	3.5 lbs	Soft Knit Wrapped on Steel Frame
72" Velcro® Message Strip	HUM1015	6"	64"	-	-	-	0.5 lb	Soft Knit with Velcro®

COMES IN
3
DISTINCT SIZES

YARD SIGNS

Our custom yard signs are made of durable coroplast.

Yard signs are great for announcing, directing, advertising or sales. They install easily on standard metal H stakes, or mount on rigid plastic Y-stakes.

Yard signs are versatile, affordable and can be printed single or double sided.

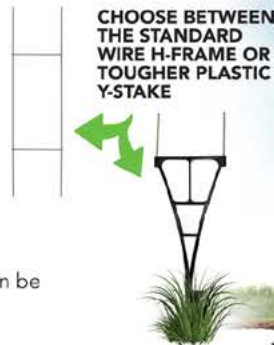

CHOOSE BETWEEN THE STANDARD WIRE H-FRAME OR TOUGHER PLASTIC Y-STAKE



*Horizontal Yard Signs Shown. Vertical Yard Signs are available also.

SS = Single Sided Print

DS = Double Sided Print

DESCRIPTION	SS	ITEM#	DS	ITEM#	GRAPHIC HEIGHT	GRAPHIC WIDTH	TOTAL HEIGHT	TOTAL WIDTH	TOTAL DEPTH	WEIGHT	MATERIAL
12" x 18" Print		AFR1080		AFR1140	12"	18"	-	-	0.15"	0.25 lb	Coroplast
18" x 24" Print		AFR1085		AFR1155	18"	24"	-	-	0.15"	0.25 lb	Coroplast
24" x 36" Print		AFR1090		AFR1075	24"	36"	-	-	0.15"	0.25 lb	Coroplast
Wire H - Stake		AFR1070		-	-	-	30"	10"	0.15"	0.15 lb	Metal
Plastic Y - Stake		AFR1185		-	-	-	26"	12"	0.5"	0.25 lb	Plastic

SKY DANCERS

INFLATABLE DISPLAYS SOLID COLOR HAPPY FACE SKY DANCER

Our solid color Sky Dancers are a simple way to grab attention on the side of a road, rooftop or event. These products stand 20' tall and are sure to attract customers from far.

Choose between 5 stock colors.
Easily sets up and tears down in minutes.

Let your customer service representative know which of the following colors you would like:



DESCRIPTION	ITEM#	GRAPHIC HEIGHT	GRAPHIC WIDTH	TOTAL HEIGHT	TOTAL WIDTH	TOTAL DEPTH	WEIGHT	MATERIAL
20' Red Sky Dancer	SKD1040	228"	19" Diameter	-	-	-	2 lbs	Polyamide Nylon Silk
20' Yellow Sky Dancer	SKD1045	228"	19" Diameter	-	-	-	2 lbs	Polyamide Nylon Silk
20' White Sky Dancer	SKD1050	228"	19" Diameter	-	-	-	2 lbs	Polyamide Nylon Silk
20' Blue Sky Dancer	SKD1055	228"	19" Diameter	-	-	-	2 lbs	Polyamide Nylon Silk
20' Black Sky Dancer	SKD1060	228"	19" Diameter	-	-	-	2 lbs	Polyamide Nylon Silk

CUSTOM MESSAGE HAPPY FACE SKY DANCER

Custom message Sky Dancers allow you to add text messages on to the simple advertising solution. Choose between (3) custom styles shown in illustration.

The blower motor is 18" in diameter, with 3 speeds. Runs off a simple 110 v motor, can plug in to standard electrical outlet.

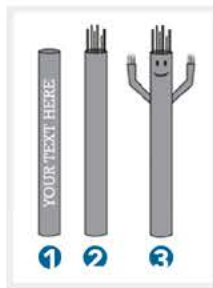

	DESCRIPTION	ITEM#	GRAPHIC HEIGHT	GRAPHIC WIDTH	TOTAL HEIGHT	TOTAL WIDTH	TOTAL DEPTH	WEIGHT	MATERIAL
1	Sky Dancer w/ Text	SKD1015	228"	19" Diameter	-	-	-	2 lbs	Polyamide Nylon Silk
2	Sky Dancer w/ Fringe	SKD1020	228"	19" Diameter	-	-	-	2 lbs	Polyamide Nylon Silk
3	Sky Dancer w/ Arms	SKD1020	228"	19" Diameter	-	-	-	2 lbs	Polyamide Nylon Silk
	Blower Motor	SKD1005	-	-	19"	18.5"	18.5"	43 lbs	Plastic



CUSTOM LED PILLAR INFLATABLE

Custom LED Pillar Inflatables are a fun and attractive way to add excitement to an entrance or path, highlight an area, or mark an event perimeter. They can also function as decorative room partitions. Pillars are great tools for temporary branding solutions - and can be fully printed with custom messages or logos.

The LED Pillar Blower, which features an internal motor that continuously rotates the blower 360 degrees, also lights up your pillar to attract every customer that walks by. The rotation blower combined with the lights is a sure way to maximize exposure for your business or event.

* LED blower motor shown is a modified illustration, therefore model could look different.

DESCRIPTION	ITEM#	GRAPHIC HEIGHT	GRAPHIC WIDTH	TOTAL HEIGHT	TOTAL WIDTH	TOTAL DEPTH	WEIGHT	MATERIAL
8' LED Pillar Inflatable	SKD1095	96"	19" Diameter	-	-	-	5 lbs	Polyamide Nylon Silk
10' LED Pillar Inflatable	SKD1100	120"	19" Diameter	-	-	-	5 lbs	Polyamide Nylon Silk
15' LED Pillar Inflatable	SKD1105	180"	19" Diameter	-	-	-	5 lbs	Polyamide Nylon Silk
20' LED Pillar Inflatable	SKD1110	240"	19" Diameter	-	-	-	5 lbs	Polyamide Nylon Silk
LED Blower Motor	SKD1075	-	-	20"	20"	7"	10 lbs	Plastic



CUSTOM NON-LED PILLAR INFLATABLE

Inflating over 7' tall, this display has 360° of advertising space. This product is produced by inflating a tube, mounting the tube on the base, and then pulling textile over inflated tube. Custom full-color printed graphics display messages simply and can be used for changing messages easily.

DESCRIPTION	ITEM#	GRAPHIC HEIGHT	GRAPHIC WIDTH	TOTAL HEIGHT	TOTAL WIDTH	TOTAL DEPTH	WEIGHT	MATERIAL
Pillowcase Print	SKD1115	72"	58.5" Diameter	-	-	-	5 lbs	Soft Knit
Non-LED Pillar & Base	SKD1085	-	-	78"	58.5" Diameter	-	10 lbs	Plastic

EXPANDABLE POP-UP DISPLAYS



COMES IN 3 DIFFERENT SIZES & VARIATIONS



*REVERSE POP-UP ILLUSTRATION IS NOT TO SCALE

POP-UP FRAME SIZES

<p>2 x 2 POP-UP Dimensions: 60" x 60" x 11.5"</p>	<p>3 x 3 POP-UP Dimensions: 90" x 90" x 11.5"</p>	<p>3 x 4 POP-UP Dimensions: 90" x 120" x 11.5"</p>
--	--	---

EXPANDABLE POP-UP DISPLAYS STANDARD POP-UP

Expandable displays are a hassle-free solution for backdrops, trade-shows and product displays. A convenient easy set-up makes this ideal for anyone needing a quick way to advertise their business or event.

HIGHLIGHTS

- ✓ Easily change, move or remove graphics
- ✓ Graphics include Velcro® strips for attaching
- ✓ Add-on accessories available to enhance pop-up display
- ✓ Digitally printed graphics on poly fabric with beautiful, rich colors
- ✓ Lightweight aluminum frame perfect for travel

DESCRIPTION	ITEM#	GRAPHIC HEIGHT	GRAPHIC WIDTH	TOTAL HEIGHT	TOTAL WIDTH	TOTAL DEPTH	WEIGHT	MATERIAL
60" x 60" Frame	POP1195	-	-	60"	60"	11.5"	17 lbs	Aluminum
Front Print	POP1035	60"	60"	-	-	-	3 lbs	Soft Knit Poly
Front & Side Print	POP1040	60"	84"	-	-	-	8 lbs	Soft Knit Poly
Full Wrap Print	POP1045	60"	144"	-	-	-	13 lbs	Soft Knit Poly
90" x 90" Frame	POP1190	-	-	90"	90"	11.5"	18.5 lbs	Aluminum
Front Print	POP1060	90"	90"	-	-	-	6 lbs	Soft Knit Poly
Front & Side Print	POP1065	90"	114"	-	-	-	11 lbs	Soft Knit Poly
Full Wrap Print	POP1070	90"	204"	-	-	-	15 lbs	Soft Knit Poly
90" x 120" Frame	POP1110	-	-	90"	120"	11.5"	20.5 lbs	Aluminum
Front Print	POP1010	90"	118"	-	-	-	11 lbs	Soft Knit Poly
Front & Side Print	POP1015	90"	145"	-	-	-	14 lbs	Soft Knit Poly
Full Wrap Print	POP1020	90"	264"	-	-	-	18 lbs	Soft Knit Poly



CURVED POP-UP

Beautiful curved backdrop to set you apart. Maintains the same function and quality as the standard walls, but built with a slight curve. Travel bag included.

POP-UP FRAME SIZES

3 x 3 POP-UP

Dimensions: 89" x 76.5" x 13.5"

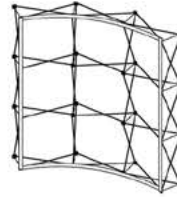

3 x 4 POP-UP

Dimensions: 89" x 117" x 14"

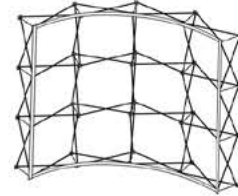

DESCRIPTION	ITEM#	GRAPHIC HEIGHT	GRAPHIC WIDTH	TOTAL HEIGHT	TOTAL WIDTH	TOTAL DEPTH	WEIGHT	MATERIAL
87" x 76.5" Frame	POP1135	-	-	89"	76.5"	13.5"	16.5 lbs	Aluminum
Front Print	POP1125	87"	76.5"	-	-	-	3 lbs	Soft Knit Poly
87" x 117" Frame	POP1140	-	-	89"	117"	14"	20.5 lbs	Aluminum
Front Print	POP1130	90"	108"	-	-	-	6 lbs	Soft Knit Poly

STANDARD & CURVED POP-UP ACCESSORIES



Protect your display from the normal wear and tear of travel with this durable travel case.

Easy to store and roll around.



Protect your display from the normal wear and tear of travel while at the same time turning the case into a beautiful graphic podium!

Case is made of a strong molded plastic that features inset wheels for easy mobility.

Graphic print is wrapped around the travel case.



Add light to your Standard or Curved Pop-Up trade show display with the Universal Pop-Up Light Kit.

Each Light sold individually

DESCRIPTION	ITEM#	GRAPHIC HEIGHT	GRAPHIC WIDTH	TOTAL HEIGHT	TOTAL WIDTH	TOTAL DEPTH	WEIGHT	MATERIAL
PVC Travel Case w/ Wheels	POP1120	-	-	38.5"	16.25"	14.75"	17 lbs	Plastic
Travel Podium Case	DSP1520	32"	72"	40"	26"	17.25"	20 lbs	Plastic
Pop - Up Light	POP1090	-	-	19.5"	5.5"	0.5" Diameter Pole	2.5 lbs	Plastic

FLAT WALL DISPLAYS

FLAT WALLS

Expandable displays are a hassle-free solution for backdrops, trade-shows and product displays. Convenient set-up makes this ideal for anyone needing a quick way to advertise their business or event. Displays are easily assembled with interlocking tubes.



Store and travel with ease with this over the shoulder soft case travel bag.



Pillowcase print slides over frame for easy installation and change of graphics



FLAT WALL

Flat walls are the new alternatives to large advertising displays. They maximize your advertising opportunities with a large design graphic area to really emphasize your message.

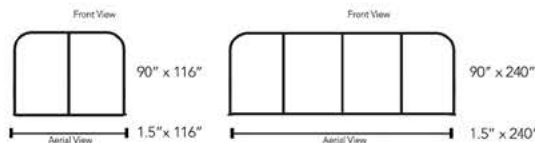

DESCRIPTION	SS	ITEM#	DS	ITEM#	GRAPHIC HEIGHT	GRAPHIC WIDTH	TOTAL HEIGHT	TOTAL WIDTH	TOTAL DEPTH	WEIGHT	MATERIAL
10' Flat Wall Frame		DSP1205		-	-	-	90"	116"	1.5"	20.5 lbs	Aluminum
10' Print		DSP1320		DSP1325	90"	116"	-	-	-	5.5 lbs	Soft Knit Poly.
20' Flat Wall Frame		DSP1590		-	-	-	90"	240"	1.5"	50 lbs	Aluminum
20' Print		DSP1645		DSP1650	90"	240"	-	-	-	11 lbs	Soft Knit Poly.

TRADESHOW KITS LED/NON-LED BOX DISPLAYS

The ultimate visual display for attracting customers to your booth! These easy-to-setup "LED/NON-LED" display kits have 2 display options. They can be LED edge lit, which vividly displays your message to every customer with rows of led lights or simply go NON-LED and display a beautifully printed textile photo. Displays come in 3 pre-cut sizes. Frames can hold a single sided print on both sides.

*For custom sized lightbox displays contact us for a custom quote.



TABLE TOP LED/NON-LED BOX

DESCRIPTION	ITEM#	GRAPHIC HEIGHT	GRAPHIC WIDTH	TOTAL HEIGHT	TOTAL WIDTH	TOTAL DEPTH	WEIGHT	MATERIAL
LED Frame	FRK4030	-	-	60"	60"	5.5"	24 lbs	Aluminum
NON-LED Frame	FRK2014	-	-	60"	60"	2.5"	10 lbs	Aluminum
Print	SEG1035	60"	60"	-	-	-	3 lbs	Lux/Samba



90" X 90" STAND-ALONE LED/NON-LED BOX

DESCRIPTION	ITEM#	GRAPHIC HEIGHT	GRAPHIC WIDTH	TOTAL HEIGHT	TOTAL WIDTH	TOTAL DEPTH	WEIGHT	MATERIAL
LED Frame	FRK4031	-	-	90"	90"	5.5"	32 lbs	Aluminum
NON-LED Frame	FRK2015	-	-	90"	90"	2.5"	18 lbs	Aluminum
Print	SEG1025	90"	90"	-	-	-	5 lbs	Lux/Samba

120" X 90" STAND-ALONE LED/NON-LED BOX

DESCRIPTION	ITEM#	GRAPHIC HEIGHT	GRAPHIC WIDTH	TOTAL HEIGHT	TOTAL WIDTH	TOTAL DEPTH	WEIGHT	MATERIAL
LED Frame	FRK4032	-	-	90"	120"	5.5"	40 lbs	Aluminum
NON-LED Frame	FRK2016	-	-	90"	120"	2.5"	26 lbs	Aluminum
Print	SEG1030	90"	120"	-	-	-	5 lbs	Lux/Samba



TRADESHOW BOOTH HEAVY DUTY TRAVEL CASE

Padded case with heavy duty travel wheels.

DESCRIPTION	ITEM#	GRAPHIC HEIGHT	GRAPHIC WIDTH	TOTAL HEIGHT	TOTAL WIDTH	TOTAL DEPTH	WEIGHT	MATERIAL
Travel Case	DSP1720	-	-	38"	48"	8"	8 lbs	Polyester

LIGHTBOX TRADESHOW
DISPLAYS

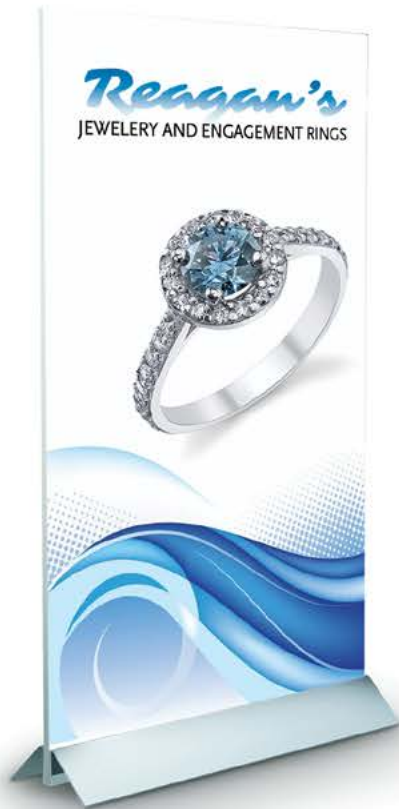

ARROW TIP SIGN HOLDER

With easy assembly and display, this stand is perfect for any advertising opportunity.

Comes with travel bag.

- ✓ M shaped steel bases accommodate up to 1" thick substrates such as styrene or foam board.
- ✓ Use with double sided graphic for front and back viewing.
- ✓ Interior holes with carriage bolts and wing nuts support any rigid graphics. Make matching holes in graphics or use without holes holding graphic above the carriage bolts.
- ✓ Extremely sturdy as all the weight is centered on the floor.
- ✓ 3-1/2" Height off floor, 9" from front to back.

SIMPLY WEDGE YOUR GRAPHIC PRINT IN BETWEEN THE TWO SIGN HOLDERS



SS = Single Sided Print

DS = Double Sided Print

DESCRIPTION	SS	ITEM#	DS	ITEM#	GRAPHIC HEIGHT	GRAPHIC WIDTH	TOTAL HEIGHT	TOTAL WIDTH	TOTAL DEPTH	WEIGHT	MATERIAL
3' Arrow Tip		DSP1605	-	-	-	-	3.5"	36"	9"	5 lbs	Aluminum
4' Arrow Tip		DSP1610	-	-	-	-	3.5"	48"	9"	8 lbs	Aluminum
5' Arrow Tip		DSP1615	-	-	-	-	3.5"	60"	9"	12 lbs	Aluminum
3' x 6' Print		DSP1525	DSP1630		72"	36"	-	-	0.15"	1 lb	Styrene or Foam Board
3' x 7' Print		DSP1525	DSP1630		84"	36"	-	-	0.15"	1.25 lbs	Styrene or Foam Board
3' x 8' Print		DSP1525	DSP1630		96"	36"	-	-	0.15"	1.25 lbs	Styrene or Foam Board
4' x 6' Print		DSP1530	DSP1635		72"	48"	-	-	0.15"	1 lb	Styrene or Foam Board
4' x 7' Print		DSP1530	DSP1635		84"	48"	-	-	0.15"	1.25 lbs	Styrene or Foam Board
4' x 8' Print		DSP1530	DSP1635		96"	48"	-	-	0.15"	1.5 lbs	Styrene or Foam Board
5' x 6' Print		DSP1535	DSP1640		72"	60"	-	-	0.15"	1.5 lbs	Styrene or Foam Board
5' x 7' Print		DSP1535	DSP1640		84"	60"	-	-	0.15"	1.75 lbs	Styrene or Foam Board
5' x 8' Print		DSP1535	DSP1640		96"	60"	-	-	0.15"	2 lbs	Styrene or Foam Board

**360°
CUSTOM
GRAPHIC
AREA**



FRONT

BACK

PERFECT FOR QUICK SETUPS & TRAVELING



Counter expands in seconds to make set ups and tear downs extremely simple and fast!

THE EXPANDABLE PROMOTIONAL COUNTER

This is perhaps the easiest to use expandable display table in the industry. Expandable, pop-up display retracts to fit into small carry case. Premium textile graphic attaches to display with Velcro®, and stays installed on base while traveling.

Travel Case included.

DESCRIPTION	ITEM#	GRAPHIC HEIGHT	GRAPHIC WIDTH	TOTAL HEIGHT	TOTAL WIDTH	TOTAL DEPTH	WEIGHT	MATERIAL
Expandable Counter	DSP1595	-	-	38"	23.5"	14"	17 lbs	Aluminum / Plastic
Wrap Around Print	DSP1655	38"	75"	-	-	-	3 lbs	Soft Knit



PROMOTERS PLANK TABLE & BAR

Add a little something extra to your trade show booth or event with a custom print on your very own Promoters Plank Table & Bar. Hassle-free set up and tear down.

DESCRIPTION	ITEM#	GRAPHIC HEIGHT	GRAPHIC WIDTH	TOTAL HEIGHT	TOTAL WIDTH	TOTAL DEPTH	WEIGHT	MATERIAL
Table & Bar	DSP1350	-	-	42.5"	40"	15"	13 lbs	Aluminum / Plastic
Front Print	DSP1340	39"	39"	-	-	-	10 lbs	Soft Knit

DISPLAYS

TABLE TOP

OPTIONAL



STANDARD TABLE TOP POP UP

Pre-assembled, this pop-up features a user-friendly design that makes set-up and take down at any event or trade show a breeze. With an extendable frame, spotlight your high-quality printed message in seconds by pulling the sleek advertising display outwards. The lightweight frame also collapses for compact storage and creates effortless transportation for your display.

Front View

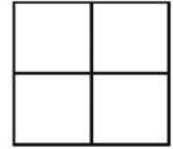

60" x 60"

Aerial View

60" x 11"

DESCRIPTION	ITEM#	GRAPHIC HEIGHT	GRAPHIC WIDTH	TOTAL HEIGHT	TOTAL WIDTH	TOTAL DEPTH	WEIGHT	MATERIAL
2 x 2 Pop-Up Frame	POP1195	-	-	60"	60"	11"	12 lbs	Aluminum
Print	POP1035	60"	60"	-	-	-	2 lbs	Soft Knit

MINI TABLE TOP X-STAND

A great, low cost promotional display for tabletop presentations. Quick assembly and ease of use make it ideal for retail/POP environments.

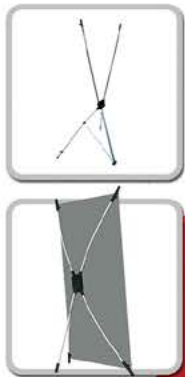

MINI VERSATILE STAND

A beautifully constructed stand with excellent stability and space for two-sided graphics. As a table top display, this can be used continuously because of its durability, thus making it a customer favorite year after year.

DESCRIPTION	ITEM#	GRAPHIC HEIGHT	GRAPHIC WIDTH	TOTAL HEIGHT	TOTAL WIDTH	TOTAL DEPTH	WEIGHT	MATERIAL
Mini X-stand Hardware	DSP1600	-	-	18"	11.75"	10.75"	1.5 lbs	Aluminum
Mini X-stand Print	DSP1715	17"	11"	-	-	-	1 lb	Clari Free Vinyl
Versatile Hardware	DSP1490	-	-	44"	12"	8"	5 lbs	Aluminum
Mini Versatile Print	DSP1545	38"	12"	-	-	-	1 lb	Clari Free Vinyl

OPTIONAL



TABLE TOP CURVED DISPLAY

Spotlight your marketing with the 6ft Table Top Curved Display and custom printed fabric. The seamless form-fitting graphic stretches over a light-weight aluminum frame. It has an elegant contoured shape and sized to fit superbly on your table top. Showcase your materials with a beautiful curved display that's sure to capture your audience at your next convention, tradeshow or promotional event. A travel case is included for storage and transportation ease.

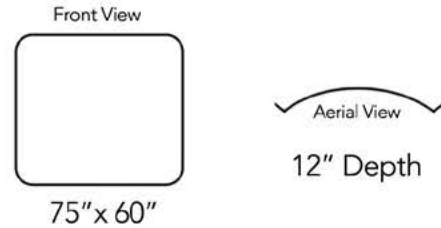

DESCRIPTION	ITEM#	GRAPHIC HEIGHT	GRAPHIC WIDTH	TOTAL HEIGHT	TOTAL WIDTH	TOTAL DEPTH	WEIGHT	MATERIAL
Table Top Curved Hardware	DSP1285	-	-	60.5"	73"	12"	4 lbs	Aluminum
Print	DSP1330	60"	75"	-	-	-	2 lbs	Soft Knit

MINI BASIC TABLE TOP RETRACTABLE

One of our lightest table top displays, this stand comes with a 3-piece shock-cord pole for easy assembly. It is perfect for tradeshow, meetings, lobbies, and retail point of sale.



MINI SELECT TABLE TOP RETRACTABLE

An elegant silver display to steal some attention and give your marketing materials a chance to shine! The small retractable hardware makes it possible to deliver a quick message to your audience with minimal effort.



DESCRIPTION	ITEM#	GRAPHIC HEIGHT	GRAPHIC WIDTH	TOTAL HEIGHT	TOTAL WIDTH	TOTAL DEPTH	WEIGHT	MATERIAL
Mini Basic Table Top Hardware	DSP1515	-	-	44"	24"	11"	7 lbs	Aluminum
Basic Table Top Print	DSP1660	40"	24"	-	-	-	1 lb	Curl Free Vinyl
Mini Select Table Top Hardware	DSP1275	-	-	18"	12.25"	4"	3 lbs	Aluminum
Select Table Top Print	DSP1335	17"	11"	-	-	-	1 lb	Curl Free Vinyl

DISPLAYS

RETRACTABLE

RETRACTABLE BANNER DISPLAYS

Get your message out with our easy set-up, retractable banner stands! Our retractable banner stands are a mobile display solution for trade show booths and commercial environments that will garner attention in a matter of seconds. Our stands have three ranges of price and function. All stands come with a basic travel bag. Stands and prints can be sold separately.



**DOUBLE SIDED
PRINT OPTION
AVAILABLE**

SUPERIOR RETRACTABLE

Our superior stand looks great, is highly durable, and very easy to use. Banners are printed on premium textiles and attach to the top and bottom of stand with Velcro®

- ✔ Telescoping pole can lock at any height between 3' and 8'
- ✔ Change prints: Reattach new banner with Velcro®

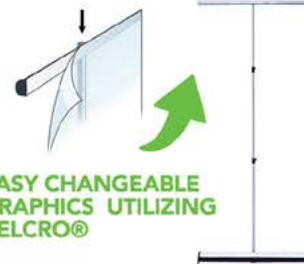

**EASY CHANGEABLE
GRAPHICS UTILIZING
VELCRO®**

HIGHLIGHTS

- ✔ Graphics Easy-Stick with Velcro®
- ✔ Easy to setup and tear down
- ✔ Comes in multiple size options

DESCRIPTION	ITEM#	GRAPHIC HEIGHT	GRAPHIC WIDTH	TOTAL HEIGHT	TOTAL WIDTH	TOTAL DEPTH	WEIGHT	MATERIAL
3' Single Sided Stand w/ Carry Case	DSP1035	-	-	98" Max	36"	8"	12 lbs	Aluminum
3' Double Sided Stand w/ Carry Case	DSP1140	-	-	98" Max	36"	10"	10 lbs	Aluminum
4' Single Sided Stand w/ Carry Case	DSP1550	-	-	98" Max	48"	8"	12 lbs	Aluminum
4' Double Sided Stand w/ Carry Case	DSP1555	-	-	98" Max	48"	10"	10 lbs	Aluminum
5' Single Sided Stand w/ Carry Case	DSP1560	-	-	98" Max	60"	8"	12 lbs	Aluminum
5' Double Sided Stand w/ Carry Case	DSP1565	-	-	98" Max	60"	10"	10 lbs	Aluminum
3' Print	DSP1030	36"	96" Max	-	-	-	1 lb	Curl Free Vinyl
4' Print	DSP1665	48"	96" Max	-	-	-	1.25 lbs	Curl Free Vinyl
5' Print	DSP1670	60"	96" Max	-	-	-	1.5 lbs	Curl Free Vinyl



SELECT RETRACTABLE

The select retractable is our industry standard for quality and aesthetics. It is our most popular stand choice. Image prints best on curl-free vinyl or laminated paper.

✔ Reusable, but changing graphic requires new adhesive

✔ Lightweight, great quality, easy to display

DESCRIPTION	ITEM#	GRAPHIC HEIGHT	GRAPHIC WIDTH	TOTAL HEIGHT	TOTAL WIDTH	TOTAL DEPTH	WEIGHT	MATERIAL
Select Stand & Carry Case	DSP1185	-	-	84"	36"	8"	12 lbs	Aluminum
Print	DSP1020	78"	33.5"	-	-	-	1 lb	Curl Free Vinyl



Premium Carry Case	DSP1460	-	-	40.5"	11.5"	4"	3 lbs	Polyester
--------------------	---------	---	---	-------	-------	----	-------	-----------

RETRACTABLES

BASIC RETRACTABLE

This basic stand is an ideal choice for price and function. Simple set up makes displaying your graphic theme an easy and economical solution for indoor advertising. Image prints best on curl-free vinyl or laminated paper.

- ✔ Extremely transportable
- ✔ Reusable, but changing graphic requires new adhesive

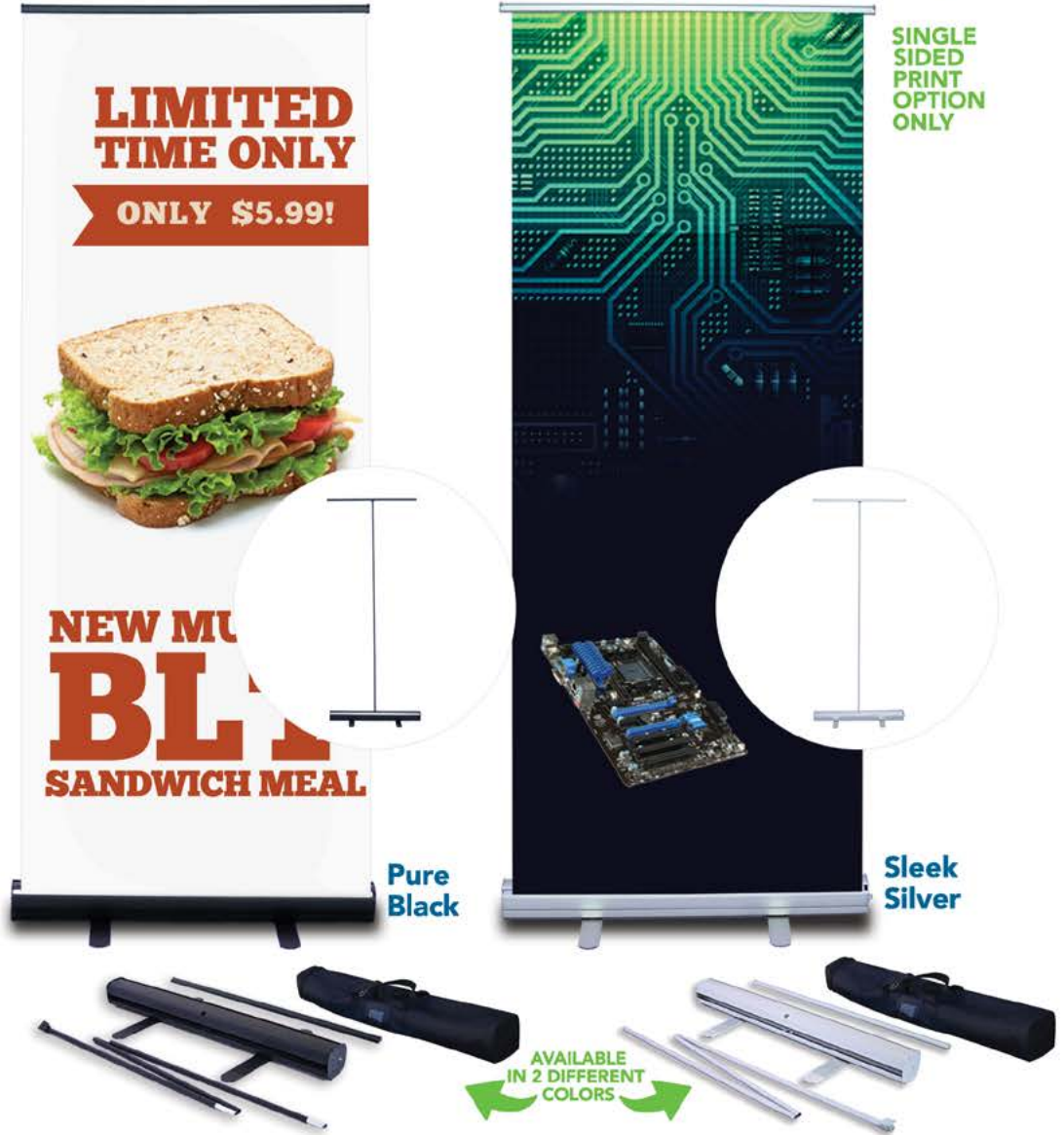

DESCRIPTION	ITEM#	GRAPHIC HEIGHT	GRAPHIC WIDTH	TOTAL HEIGHT	TOTAL WIDTH	TOTAL DEPTH	WEIGHT	MATERIAL
Pure Black Stand	DSP1305	-	-	81"	34.25"	10"	5 lbs	Aluminum
Sleek Silver Stand	DSP1210	-	-	81"	34.25"	10"	5 lbs	Aluminum
Print	DSP1010	78"	33.5"	-	-	-	1 lb	Curl Free Vinyl
Premium Carry Case*	DSP1460	-	-	40.5"	11.5"	4"	5 lbs	Polyester

* Bag seen on the bottom of page 53

JUMBO RETRACTABLE

This large retractable creates an instant game changer in every display situation. Its simple set-up makes displaying your graphic print a "no sweat" job. Image prints best on curl-free vinyl or laminated paper.

- ✔ Extremely transportable
- ✔ Reusable, but changing graphic requires new adhesive



DESCRIPTION	ITEM#	GRAPHIC HEIGHT	GRAPHIC WIDTH	TOTAL HEIGHT	TOTAL WIDTH	TOTAL DEPTH	WEIGHT	MATERIAL
Jumbo Stand	DSP1270	-	-	80"	96"	8"	22 lbs	Aluminum
Print	DSP1345	80"	94"	-	-	-	3 lbs	Curl Free Vinyl



THE SWITCHBLADE RETRACTABLE

The Switchblade is a double sided stand that has a sleek silver base and a wonderfully thought out compact design. Easy to assemble, this stand has a snap top graphic rail that makes adding your graphic to it super easy!

- ✔ Double Sided
- ✔ 3-Piece Bungee Pole Set
- ✔ Anodized Silver Base
- ✔ Molded End Caps
- ✔ Swivel Out Feet



DESCRIPTION	ITEM#	GRAPHIC HEIGHT	GRAPHIC WIDTH	TOTAL HEIGHT	TOTAL WIDTH	TOTAL DEPTH	WEIGHT	MATERIAL
Switchblade Stand	DSP1495	-	-	82"	36"	12"	16 lbs	Aluminum
Print	DSP1675	78"	33.5"	-	-	-	1 lb	Curl Free Vinyl

X-STAND

This black economy stand ships in a travel bag, and expands to an X shape. The graphic is installed using grommets in each corner. Image prints best on vinyl or Poly 600.

- ✔ An easy, inexpensive way to communicate your message
- ✔ Now offering 2 sizes
- ✔ Basic storage bag included



DESCRIPTION	ITEM#	GRAPHIC HEIGHT	GRAPHIC WIDTH	TOTAL HEIGHT	TOTAL WIDTH	TOTAL DEPTH	WEIGHT	MATERIAL
Small X-Stand	DSP1215	-	-	65.5"	32.5"	25"	2 lbs	Fiberglass
Small Print	DSP1355	65.5"	25.5"	-	-	-	1 lb	Curl Free Vinyl
Large X-Stand	DSP1260	-	-	77"	32.5"	26"	2.7 lbs	Fiberglass
Large Print	DSP1360	67"	30"	-	-	-	1 lb	Curl Free Vinyl

VERSATILE STAND

An extremely affordable and vertically adjustable lobby display, this stand can hold 2 single sided prints. Prints can be any size ranging from 24" to 96" in height. Image prints best on curl-free vinyl or laminated paper.

- ✓ Extremely transportable
- ✓ Reusable, but changing graphic requires new adhesive



HIGHLIGHTS

- ✓ Breaks down in seconds
- ✓ Resists wear & tear
- ✓ Strong and Durable
- ✓ Holds 2 single sided prints

DESCRIPTION	ITEM#	GRAPHIC HEIGHT	GRAPHIC WIDTH	TOTAL HEIGHT	TOTAL WIDTH	TOTAL DEPTH	WEIGHT	MATERIAL
Versatile Stand	DSP1170	-	-	102" Max	24"	13"	12 lbs	Aluminum
Print	DSP1175	96" Max	24"	-	-	-	1 lb	Poly 600

FRAMES TEXTILE & LIGHT BOX

SILICONE-EDGED TEXTILE FRAMES

Whether you are looking for a permanent installation or highly visible portable display, our textile frame light-box options offer a professional look for any advertising need.



NON-LED & LED FRAME ASSEMBLY

All of our textile frame products combine ingeniously-designed rigid frames with the softness of beautiful textile prints. The prints are fitted with a silicone strip that fits exactly into the groove of the frame. The images below illustrate this concept.

Mounting prints with silicone strips is easy. The quality is exceptional, whatever the size of the frame. You will not be able to discover a single crease, even in displays as large as 20 x 10 feet, and installing a print takes only a matter of minutes. Should anything be unclear, do not hesitate to contact for help.



HIGHLIGHTS

- ✓ Easy to change out prints even without any experience
- ✓ A high-quality innovative appearance that distinguishes you from all other point of sales products
- ✓ Compact and lightweight



FRAME ASSEMBLY

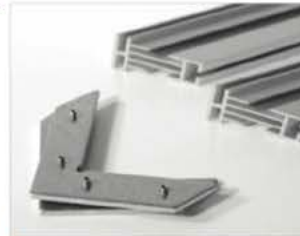

Parts
Profile with corner connectors



Step 1
Place one corner connector per corner



Step 2
Use allen key to tighten screws



Step 3
Press silicone strip in the profile groove

SILICON-EDGED LED FRAMES

Textile light boxes use aluminum extrusion frames and push-fit fabric graphics. Frames listed are available with or without LED lighting, and are single or double sided. LED lights easily attach to the frame, making set-up as simple as assembling the frame, applying the push-fit graphics and plugging in the electrical cord!



AVAILABLE SIZES

Choose one of these beautiful textile frames and enhance the visual appeal in your store. All frames are 78" in height and width size ranges from 24" to 60". **Custom sizes are available.**

Each frame has a NON-LED and LED option to choose from. Premium Travel Case also available for both styles.



DESCRIPTION	ITEM#	GRAPHIC HEIGHT	GRAPHIC WIDTH	TOTAL HEIGHT	TOTAL WIDTH	TOTAL DEPTH	WEIGHT	MATERIAL
24" Textile Frame (Single Sided)	FRK1018	-	-	78"	24"	1" Frame	10 lbs	Aluminum
24" Textile Frame (Double Sided)	FRK2008	-	-	78"	24"	1.25" Frame	15 lbs	Aluminum
24" LED Frame w/ Feet (Single Sided)	FRK3019	-	-	78"	24"	2.5" Frame	16 lbs	Aluminum
24" LED Frame w/ Feet (Double Sided)	FRK4024	-	-	78"	24"	5.5" Frame	28 lbs	Aluminum
24" Print	SEG1000	78"	24"	-	-	-	1.25 lbs	Lux/Samba
30" Textile Frame (Single Sided)	FRK1019	-	-	78"	30"	1" Frame	12 lbs	Aluminum
30" Textile Frame (Double Sided)	FRK2009	-	-	78"	30"	1.25" Frame	17 lbs	Aluminum
30" LED Frame w/ Feet (Single Sided)	FRK3020	-	-	78"	30"	2.5" Frame	18 lbs	Aluminum
30" LED Frame w/ Feet (Double Sided)	FRK4025	-	-	78"	30"	5.5" Frame	30 lbs	Aluminum
30" Print	SEG1005	78"	30"	-	-	-	1.5 lbs	Lux/Samba
36" Textile Frame (Single Sided)	FRK1020	-	-	78"	36"	1" Frame	14 lbs	Aluminum
36" Textile Frame (Double Sided)	FRK2010	-	-	78"	36"	1.25" Frame	18 lbs	Aluminum
36" LED Frame w/ Feet (Single Sided)	FRK3021	-	-	78"	36"	2.5" Frame	20 lbs	Aluminum
36" LED Frame w/ Feet (Double Sided)	FRK4026	-	-	78"	36"	5.5" Frame	34 lbs	Aluminum
36" Print	SEG1010	78"	36"	-	-	-	1.75 lbs	Lux/Samba
48" Textile Frame (Single Sided)	FRK1021	-	-	78"	48"	1" Frame	16 lbs	Aluminum
48" Textile Frame (Double Sided)	FRK2011	-	-	78"	48"	1.25" Frame	20 lbs	Aluminum
48" LED Frame w/ Feet (Single Sided)	FRK3022	-	-	78"	48"	2.5" Frame	22 lbs	Aluminum
48" LED Frame w/ Feet (Double Sided)	FRK4027	-	-	78"	48"	5.5" Frame	38 lbs	Aluminum
48" Print	SEG1015	78"	30"	-	-	-	2 lbs	Lux/Samba

ECONOMY TABLE DRAPES

TABLE DRAPES, COVERS, RUNNERS & THROWS ECONOMY SCREEN PRINTED (DRAPE OR BOX FIT) FOUR SIDED TABLE COVER

Table covers and drapes are printed on polyester fabrics with dispersed dyes. All sizes are flame retardant. These drapes can be machine washed after use. Drapes are produced using screen-printing.



Front View



Back View
4 - Sided

DESCRIPTION	ITEM#	GRAPHIC HEIGHT	GRAPHIC WIDTH	TOTAL HEIGHT	TOTAL WIDTH	TOTAL DEPTH	WEIGHT	MATERIAL
4ft - Four Sided Table Cover	TCV1200	88"	108"	90"	108"	-	3 lbs	Soft Knit
6ft - Four Sided Table Cover	TCV1205	88"	132"	90"	132"	-	4 lbs	Soft Knit
8ft - Four Sided Table Cover	TCV1210	88"	154"	90"	156"	-	5 lbs	Soft Knit



Front View



Back View
3 - Sided

THREE SIDED TABLE COVER

Three sided table covers are perfect for those who are wanting leg or storage space with easy access. The short side of the table cover hangs 30" from the edge of the back of the table.

DESCRIPTION	ITEM#	GRAPHIC HEIGHT	GRAPHIC WIDTH	TOTAL HEIGHT	TOTAL WIDTH	TOTAL DEPTH	WEIGHT	MATERIAL
4ft - Three Sided Table Cover	TCV1185	72"	108"	72"	108"	-	2.5 lbs	Soft Knit
6ft - Three Sided Table Cover	TCV1190	72"	132"	72"	132"	-	3 lbs	Soft Knit
8ft - Three Sided Table Cover	TCV1195	72"	154"	72"	156"	-	4 lbs	Soft Knit

PREMIUM DIGITAL - PREMIUM FABRIC (DRAPE OR BOX FIT) FOUR SIDED TABLE COVER

Table covers and drapes are printed on polyester fabrics with dispersed dyes. All sizes are flame retardant. These drapes can be machine washed after use. Drapes are produced using full color digital printing.



Front View



Back View
4 - Sided

PREMIUM TABLE DRAPES

DESCRIPTION	ITEM#	GRAPHIC HEIGHT	GRAPHIC WIDTH	TOTAL HEIGHT	TOTAL WIDTH	TOTAL DEPTH	WEIGHT	MATERIAL
4ft - Four Sided Table Cover	TCV1025	88"	108"	90"	108"	-	3 lbs	Soft Knit
6ft - Four Sided Table Cover	TCV1030	88"	132"	90"	132"	-	4 lbs	Soft Knit
8ft - Four Sided Table Cover	TCV1035	88"	154"	90"	156"	-	5 lbs	Soft Knit



Front View



Back View
3 - Sided

THREE SIDED TABLE COVER

Three sided table covers are perfect for those who are wanting leg or storage space with easy access. The short side of the table cover hangs 30" from the edge of the back of the table.

DESCRIPTION	ITEM#	GRAPHIC HEIGHT	GRAPHIC WIDTH	TOTAL HEIGHT	TOTAL WIDTH	TOTAL DEPTH	WEIGHT	MATERIAL
4ft - Three Sided Table Cover	TCV1010	72"	108"	72"	108"	-	2.5 lbs	Soft Knit
6ft - Three Sided Table Cover	TCV1015	72"	132"	72"	132"	-	3 lbs	Soft Knit
8ft - Three Sided Table Cover	TCV1020	72"	154"	72"	156"	-	4 lbs	Soft Knit

GOVERS STRETCH

ECONOMY - 110 GRAMS CUSTOM STRETCH TABLE COVER

Table covers and drapes are printed on polyester fabrics with dispersed dyes. They are both flame retardant and wrinkle resistant. These drapes can be machine washed after use. Drapes are produced using screen-printing or full color, digital printing. These covers boast a sleek, modern look and are perfect for any event.

Front View



Back View
4 - Sided

ECONOMY 4-SIDED STRETCH TABLE COVER

DESCRIPTION	ITEM#	GRAPHIC HEIGHT	GRAPHIC WIDTH	TOTAL HEIGHT	TOTAL WIDTH	TOTAL DEPTH	WEIGHT	MATERIAL
4ft - Four Sided Stretch Cover	TCV1230	89"	106.5"	90"	108"	-	3 lbs	110g Stretch
6ft - Four Sided Stretch Cover	TCV1235	89"	129.5"	90"	132"	-	4 lbs	110g Stretch
8ft - Four Sided Stretch Cover	TCV1240	89"	154"	90"	156"	-	5 lbs	110g Stretch
4ft - Four Sided Stretch Cover w/ Zipper	TCV1245	89"	106.5"	90"	108"	-	3 lbs	110g Stretch
6ft - Four Sided Stretch Cover w/ Zipper	TCV1250	89"	129.5"	90"	132"	-	4 lbs	110g Stretch
8ft - Four Sided Stretch Cover w/ Zipper	TCV1255	89"	154"	90"	156"	-	5 lbs	110g Stretch

All sides of the stretch table cover can be designed and printed on.



Easy to Zip Up
and Secure

HIGHLIGHTS

- ✓ Stretched tight material keeps message legible
- ✓ Beautiful, digitally printed graphics on high quality textiles
- ✓ Print anywhere in all colors



Front View

Back View
3 - Sided

ECONOMY 3-SIDED STRETCH TABLE COVER

DESCRIPTION	ITEM#	GRAPHIC HEIGHT	GRAPHIC WIDTH	TOTAL HEIGHT	TOTAL WIDTH	TOTAL DEPTH	WEIGHT	MATERIAL
4ft - Three Sided Stretch Cover	TCV1215	89"	106.5"	90"	108"	-	2.5 lbs	110g Stretch
6ft - Three Sided Stretch Cover	TCV1220	89"	129.5"	90"	132"	-	3 lbs	110g Stretch
8ft - Three Sided Stretch Cover	TCV1225	89"	154"	90"	156"	-	4 lbs	110g Stretch

All sides of the stretch table cover can be designed and printed on.

PREMIUM - 180 GRAMS CUSTOM STRETCH TABLE COVER

Table covers and drapes are printed on polyester fabrics with dispersed dyes. They are both flame retardant and wrinkle resistant. These drapes can be machine washed after use. Drapes are produced using screen-printing or full color, digital printing. These covers boast a sleek, modern look and are perfect for any event.



PREMIUM 4-SIDED STRETCH TABLE COVER

DESCRIPTION	ITEM#	GRAPHIC HEIGHT	GRAPHIC WIDTH	TOTAL HEIGHT	TOTAL WIDTH	TOTAL DEPTH	WEIGHT	MATERIAL
4ft - Four Sided Stretch Cover	TCV1160	89"	106.5"	90"	108"	-	3 lbs	Power Stretch
6ft - Four Sided Stretch Cover	TCV1170	89"	129.5"	90"	132"	-	4 lbs	Power Stretch
8ft - Four Sided Stretch Cover	TCV1180	89"	154"	90"	156"	-	5 lbs	Power Stretch
4ft - Four Sided Stretch Cover w/ Zipper	TCV1260	89"	106.5"	90"	108"	-	3 lbs	Power Stretch
6ft - Four Sided Stretch Cover w/ Zipper	TCV1265	89"	129.5"	90"	132"	-	4 lbs	Power Stretch
8ft - Four Sided Stretch Cover w/ Zipper	TCV1270	89"	154"	90"	156"	-	5 lbs	Power Stretch

All sides of the stretch table cover can be designed and printed on.



PREMIUM 3-SIDED STRETCH TABLE COVER

DESCRIPTION	ITEM#	GRAPHIC HEIGHT	GRAPHIC WIDTH	TOTAL HEIGHT	TOTAL WIDTH	TOTAL DEPTH	WEIGHT	MATERIAL
4ft - Three Sided Stretch Cover	TCV1155	89"	106.5"	90"	108"	-	2.5 lbs	Power Stretch
6ft - Three Sided Stretch Cover	TCV1165	89"	129.5"	90"	132"	-	3 lbs	Power Stretch
8ft - Three Sided Stretch Cover	TCV1175	89"	154"	90"	156"	-	4 lbs	Power Stretch

All sides of the stretch table cover can be designed and printed on.

GOVERS RUNNER & THROW

TABLE RUNNER/THROW

The Table Runner is ideal for accenting solid colored table covers, while the Table Throw is perfect to use as a front table cover that has a 10" run off on the back of it. Both are great additions to promote your brand.

Table Throw Shown



Table Runner Shown



Standard white table cover and table are not included.

DESCRIPTION	ITEM#	GRAPHIC HEIGHT	GRAPHIC WIDTH	TOTAL HEIGHT	TOTAL WIDTH	TOTAL DEPTH	WEIGHT	MATERIAL
28" Runner/Throw	TCV1055	72"	28"	-	-	-	2 lbs	Soft Knit
36" Runner/Throw	TCV1150	72"	36"	-	-	-	2 lbs	Soft Knit
48" Runner/Throw	TCV1040	72"	48"	-	-	-	3 lbs	Soft Knit
57" Runner/Throw	TCV1060	72"	57"	-	-	-	3 lbs	Soft Knit
72" Runner/Throw	TCV1045	72"	72"	-	-	-	3 lbs	Soft Knit
96" Runner/Throw	TCV1050	72"	96"	-	-	-	6 lbs	Soft Knit

CONVERTIBLE TABLE COVER

The Convertible Table Cover is the perfect table cover for those who do many events, conferences and shows. It gives you the versatility of adjusting your table to 2 different table sizes, preparing you for any situation.



PERFECTLY FITS 2 DIFFERENT SIZED TABLES

Transforms down or up a size in a matter of seconds!



Velcro® strips keep loose drapery hidden until time of conversion.



DESCRIPTION	ITEM#	GRAPHIC HEIGHT	GRAPHIC WIDTH	TOTAL HEIGHT	TOTAL WIDTH	TOTAL DEPTH	WEIGHT	MATERIAL
4ft - 6ft Convertible Table Cover	TCV1275	89"	48" - 72"	-	-	-	3 lbs	Soft Knit & Velcro®
6ft - 8ft Convertible Table Cover	TCV1280	89"	72" - 96"	-	-	-	4 lbs	Soft Knit & Velcro®
8ft - 10ft Convertible Table Cover	TCV1285	89"	96" - 120"	-	-	-	5 lbs	Soft Knit & Velcro®

THE HALO BANNER SYSTEM



THE HALO BANNER

The Halo Banner system is a new and creative way to attract and advertise to customers from all 360° views. Perfectly designed for all types of poles, ranging from 4' to 8' in length, this system creates a beautiful look for concerts, restaurants, sporting events, mall parking lots and every outdoor event where mountable poles are available.

Prints are full color and printed on our Poly 600 material.

Sizes range from 48" to 96" in height.



DESCRIPTION	ITEM#	GRAPHIC HEIGHT	GRAPHIC WIDTH	TOTAL HEIGHT	TOTAL WIDTH	TOTAL DEPTH	WEIGHT	MATERIAL
4ft Halo Banner Print	AVE1195	48"	75.35"	-	-	-	3 lbs	Poly 600
6ft Halo Banner Print	AVE1200	72"	75.35"	-	-	-	4 lbs	Poly 600
8ft Halo Banner Print	AVE1205	96"	75.35"	-	-	-	5 lbs	Poly 600
Hardware Kit	DSP1680	-	-	2" per plastic band	25" Diameter	-	6 lbs	Plastic, Metal & Velcro®



**LITE HARDWARE
AND EASY
TO ASSEMBLE!**

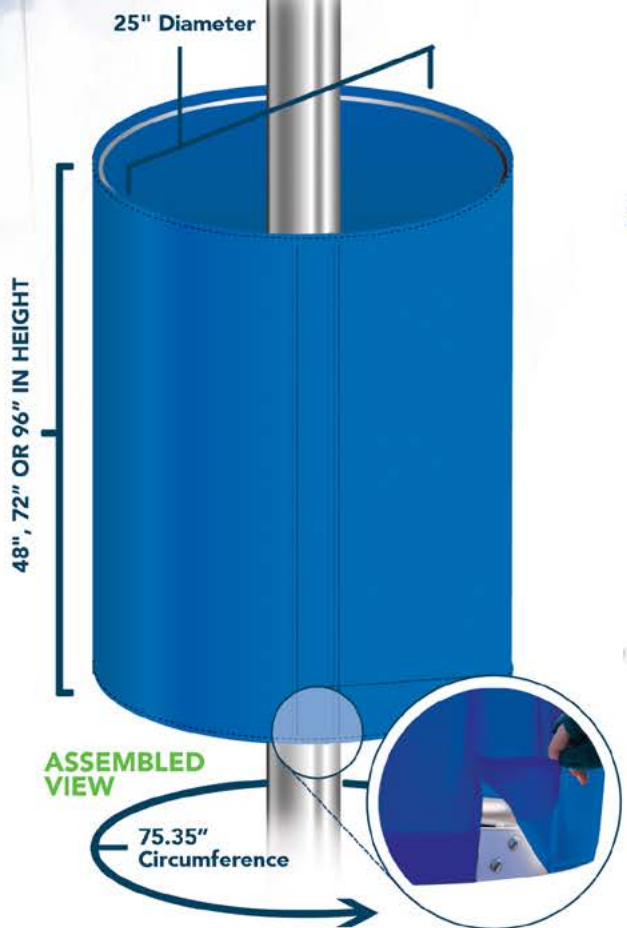

KIT COMPONENTS



**HARDWARE
AERIAL VIEW**



**BRACKET
MOUNTED TO RING**



**2 METAL
BRACKET STRAPS**

1 BANNER



**ADD FULL
COLOR DESIGN**

PRINTED MATERIAL: POLY 600

Velcro Strip: 1" x 24"

AVENUE BANNERS



AVENUE BANNERS

A great way for cities, towns, apartment complexes and many others to promote themselves, Avenue banners are attached to light poles with two aluminum brackets. The banner has a standard fold-over pole pocket on the top and bottom, with sewn, vertical edges and 2 brass grommets.

HIGHLIGHTS

- ✓ High-Quality hardware for incredible stability
- ✓ Array of materials to print on
- ✓ Large range of sizes to advertise your event
- ✓ Easy assembly and changeout of graphics



Single reverse banners are printed on nylon, while double sided prints are printed on vinyl.

AVENUE BANNER PRINT & CONSTRUCTION OPTIONS

SINGLE SIDE OF THE POLE WITH SINGLE REVERSE PRINT	<div style="background-color: #90ee90; padding: 2px; display: inline-block;">1SR</div>
SINGLE SIDE OF THE POLE WITH DOUBLE SIDED PRINT	<div style="background-color: #90ee90; padding: 2px; display: inline-block;">1DS</div>
DUAL SIDE OF THE POLE WITH SINGLE REVERSE PRINT	<div style="background-color: #90ee90; padding: 2px; display: inline-block;">2SR</div>
DUAL SIDE OF THE POLE WITH DOUBLE SIDED PRINT	<div style="background-color: #90ee90; padding: 2px; display: inline-block;">2DS</div>



SIZE CHART



AVENUE BANNER

SR = Single Reverse

DS = Double Sided

TEXTILE	DESCRIPTION	SR	ITEM#	DS	ITEM#	GRAPHIC HEIGHT	GRAPHIC WIDTH	TOTAL HEIGHT	TOTAL WIDTH	TOTAL DEPTH	WEIGHT	MATERIAL
	28" x 48" Print		AVE1135		AVE1140	48"	28"	-	-	-	3 lbs	Poly 600
	28" x 60" Print		AVE1010		AVE1015	60"	28"	-	-	-	4 lbs	Poly 600
	28" x 72" Print		AVE1020		AVE1025	72"	28"	-	-	-	5 lbs	Poly 600
	28" x 96" Print		AVE1030		AVE1035	96"	28"	-	-	-	6 lbs	Poly 600

SS = Single Sided

DS = Double Sided

VINYL	DESCRIPTION	SS	ITEM#	DS	ITEM#	GRAPHIC HEIGHT	GRAPHIC WIDTH	TOTAL HEIGHT	TOTAL WIDTH	TOTAL DEPTH	WEIGHT	MATERIAL
	28" x 48" Print		AVE1145		AVE1150	48"	28"	-	-	-	3 lbs	13oz. Vinyl
	28" x 60" Print		AVE1040		AVE1045	60"	28"	-	-	-	4 lbs	13oz. Vinyl
	28" x 72" Print		AVE1050		AVE1055	72"	28"	-	-	-	5 lbs	13oz. Vinyl
	28" x 96" Print		AVE1060		AVE1065	96"	28"	-	-	-	6 lbs	13oz. Vinyl

CITY BANNER MOUNTING SYSTEM

The City Banner System is our most popular avenue banner kit. Made of casted metal with white fiberglass dowels, these pieces are economically priced yet durable. They function extremely well in areas with lower wind conditions. This system includes all required mounting hardware.



DESCRIPTION	ITEM#	GRAPHIC HEIGHT	GRAPHIC WIDTH	TOTAL HEIGHT	TOTAL WIDTH	TOTAL DEPTH	WEIGHT	MATERIAL
Single Side of Pole Hardware Set	AVE1100	-	-	32"	0.75" Diameter	-	4.5 lbs	Fiberglass & Steel
Double Side of Pole Hardware Set	AVE1105	-	-	32" (64" Total)	0.75" Diameter	-	8.5 lbs	Fiberglass & Steel

THE COMMERCIAL



THE COMMERCIAL FRAME

Our most popular frame - the Commercial Tent Frame - is the highest-quality standard tent frame available. With thick-walled, hexagonal aluminum tubing, this tent frame is the best in the business.

FUN FACT:

The tough frame is built strong enough to hold up to 50lbs on its bracing arms. It is also the #1 selling tent we carry.



7' x 7'

DESCRIPTION	ITEM#	GRAPHIC HEIGHT	GRAPHIC WIDTH	TOTAL HEIGHT	TOTAL WIDTH	TOTAL DEPTH	WEIGHT	MATERIAL
7'x 7' Tent Frame	TNT1095	-	-	98.5" / 111"	84"	84"	28 lbs	Aluminum
Screen Print Tent Top 1 Location	TNT1835	70"	220"	-	-	-	5 lbs	400D Poly
Full Digital Tent Top	TNT1065	70"	220"	-	-	-	5 lbs	400D Poly
4 Color Screen Print Tent Top	TNT1855	70"	220"	-	-	-	5 lbs	400D Poly
Soft Tent Bag w/ Wheels	TNT1180	-	-	62"	14"	12"	5.5 lbs	Polyester



10' x 10'

10'x 10' Tent Frame	TNT1040	-	-	97.5" / 132"	120"	120"	37.5 lbs	Aluminum
Screen Print Tent Top 1 Location	TNT1840	95"	330"	-	-	-	6 lbs	400D Poly
Full Digital Tent Top	TNT1010	95"	330"	-	-	-	6 lbs	400D Poly
4 Color Screen Print Tent Top	TNT1860	95"	330"	-	-	-	6 lbs	400D Poly
Soft Tent Bag w/ Wheels	TNT1180	-	-	62"	14"	12"	5.5 lbs	Polyester



15' x 10'

15'x 10' Tent Frame	TNT1205	-	-	97.5" / 132"	180"	120"	46 lbs	Aluminum
Screen Print Tent Top 1 Location	TNT1845	95"	460"	-	-	-	9 lbs	400D Poly
Full Digital Tent Top	TNT1245	95"	460"	-	-	-	9 lbs	400D Poly
4 Color Screen Print Tent Top	TNT1865	95"	460"	-	-	-	9 lbs	400D Poly
Soft Tent Bag w/ Wheels	TNT1225	-	-	62"	17"	12"	7 lbs	Polyester



20' x 10'

20'x 10' Tent Frame	TNT1220	-	-	97.5" / 132"	240"	120"	62.5 lbs	Aluminum
Screen Print Tent Top 1 Location	TNT1850	95"	570"	-	-	-	12 lbs	400D Poly
Full Digital Tent Top	TNT1270	95"	570"	-	-	-	12 lbs	400D Poly
4 Color Screen Print Tent Top	TNT1870	95"	570"	-	-	-	12 lbs	400D Poly
Soft Tent Bag w/ Wheels	TNT1225	-	-	62"	17"	12"	7 lbs	Polyester

HOW TO DECORATE YOUR TENT TOP

NON-PRINTED (Solid Color Tent Top)



Looking for Solid Color Top? No problem! Just pick a color. Call your customer service representative for size & color availability.

① Pick a background color for your tent top



SCREEN PRINT (1 Color Top // Up to 4 Logo Locations)



The Screen Print option is only available when orders of 12+ full color tent tops are placed.

① Pick a background color for your tent top



② Determine the # of location prints per color



EXAMPLE 1:
1 Color | 1 Logo Location



EXAMPLE 2:
1 Color | 4 Logo Locations

FULL COLOR PRINT (Digitally Printed)



DIGITAL PRINT

Printing digitally allows you to fully design your tent top any way you would like. With direct-to-fabric printing, this process allows for great detail and beautiful, deep, rich colors.

Don't let your design be held back....Go Digital!



EXAMPLE 1:
Design on any area of the top of the tent

FULL COLOR PRINT (4 Color Process Print // Non-Digital)



The 4 color process screen print option is only available when orders of 12+ full color tent tops are placed.



SCREEN PRINT



EXAMPLE 1:
Design on any area of the top of the tent

THE PRO TENT



FUN FACT:
The PRO Tent Frame is our strongest tent we offer. Up to 125 lbs can be hung on its arms. Each leg is 2.25" in diameter.

* Soft Tent Travel Bag with wheels included with every tent frame purchase.

THE PRO TENT FRAME

The most durable and strongest tent frame in the industry. Durable and tough, this tent is made to withstand harsh outdoor conditions. With 2.25" thick-walled, hexagonal aluminum tubing and nylon components, this tent frame is the strongest the industry has to offer.



10' x 10'

DESCRIPTION	ITEM#	GRAPHIC HEIGHT	GRAPHIC WIDTH	TOTAL HEIGHT	TOTAL WIDTH	TOTAL DEPTH	WEIGHT	MATERIAL
10'x 10' Tent Frame	TNT1440	-	-	99" / 135"	120"	120"	65 lbs	High Grade Aluminum
Screen Print Tent Top 1 Location	TNT1890	95"	330"	-	-	-	6 lbs	400D Poly
Full Digital Tent Top	TNT1875	95"	330"	-	-	-	6 lbs	400D Poly
4 Color Screen Print Tent Top	TNT1905	95"	330"	-	-	-	6 lbs	400D Poly
Soft Tent Bag w/ Wheels	TNT1445	-	-	64"	14"	14"	11 lbs	Polyester



15' x 10'

15'x 10' Tent Frame	TNT1450	-	-	97.5" / 135"	180"	120"	92 lbs	High Grade Aluminum
Screen Print Tent Top 1 Location	TNT1895	95"	460"	-	-	-	9 lbs	400D Poly
Full Digital Tent Top	TNT1880	95"	460"	-	-	-	9 lbs	400D Poly
4 Color Screen Print Tent Top	TNT1910	95"	460"	-	-	-	9 lbs	400D Poly
Soft Tent Bag w/ Wheels	TNT1455	-	-	64"	18"	14"	14 lbs	Polyester



20' x 10'

20'x 10' Tent Frame	TNT1460	-	-	99" / 135"	240"	120"	117.5 lbs	High Grade Aluminum
Screen Print Tent Top 1 Location	TNT1900	95"	570"	-	-	-	12 lbs	400D Poly
Full Digital Tent Top	TNT1885	95"	570"	-	-	-	12 lbs	400D Poly
4 Color Screen Print Tent Top	TNT1915	95"	570"	-	-	-	12 lbs	400D Poly
Soft Tent Bag w/ Wheels	TNT1465	-	-	64"	24"	14"	16.5 lbs	Polyester

HOW TO DECORATE YOUR TENT TOP

NON-PRINTED (Solid Color Tent Top)



Looking for Solid Color Top? No problem! Just pick a color. Call your customer service representative for size & color availability.

① Pick a background color for your tent top



SCREEN PRINT (1 Color Top // Up to 4 Logo Locations)



The Screen Print option is only available when orders of 12+ full color tent tops are placed.

① Pick a background color for your tent top



② Determine the # of location prints per color



EXAMPLE 1:
1 Color | 1 Logo Location



EXAMPLE 2:
1 Color | 4 Logo Locations

FULL COLOR PRINT (Digitally Printed)



DIGITAL PRINT

Printing digitally allows you to fully design your tent top any way you would like. With direct-to-fabric printing, this process allows for great detail and beautiful, deep, rich colors.

Don't let your design be held back....Go Digital!



EXAMPLE 1:
Design on any area of the top of the tent

FULL COLOR PRINT (4 Color Process Print // Non-Digital)



The 4 color process screen print option is only available when orders of 12+ full color tent tops are placed.



EXAMPLE 1:
Design on any area of the top of the tent

THE PROMO



THE PROMO FRAME

Our most affordable tent frame kit, the Promo Tent Frame, is a great tent for those who are budget conscious but still want a beautiful, well-built tent! The Promo Tent Frame is made of a white colored steel and is easy to pack and transport. This tent kit is perfect for those needing something that is affordable yet provides an option of customization.



	DESCRIPTION	ITEM#	GRAPHIC HEIGHT	GRAPHIC WIDTH	TOTAL HEIGHT	TOTAL WIDTH	TOTAL DEPTH	WEIGHT	MATERIAL
5' x 5'	5'x 5' Tent Frame	TNT1805	-	-	80" / 119"	59.5"	59.5"	33 lbs	Steel
	Screen Print Tent Top 1 Location	TNT1930	50.5"	240"	-	-	-	6 lbs	400D Poly
	Full Digital Tent Top	TNT1920	50.5"	240"	-	-	-	6 lbs	400D Poly
	4 Color Screen Print Tent Top	TNT1940	50.5"	240"	-	-	-	6 lbs	400D Poly
	Soft Tent Bag w/ Wheels	TNT1435	-	-	63"	12"	10.5"	5.5" lbs	Polyester



10' x 10'	10'x 10' Tent Frame	TNT1430	-	-	98.5" / 132"	118.5"	118.5"	48.5 lbs	Steel
	Screen Print Tent Top 1 Location	TNT1925	95"	330"	-	-	-	6 lbs	400D Poly
	Full Digital Tent Top	TNT1500	95"	330"	-	-	-	6 lbs	400D Poly
	4 Color Screen Print Tent Top	TNT1935	95"	330"	-	-	-	6 lbs	400D Poly
	Soft Tent Bag w/ Wheels	TNT1435	-	-	63"	12"	10.5"	5.5" lbs	Polyester

HOW TO DECORATE YOUR TENT TOP

NON-PRINTED (Solid Color Tent Top)



Looking for Solid Color Top? No problem! Just pick a color. Call your customer service representative for size & color availability.

① Pick a background color for your tent top



SCREEN PRINT (1 Color Top // Up to 4 Logo Locations)



The Screen Print option is only available when orders of 12+ full color tent tops are placed.

① Pick a background color for your tent top



② Determine the # of location prints per color



EXAMPLE 1:
1 Color | 1 Logo Location



EXAMPLE 2:
1 Color | 4 Logo Locations

FULL COLOR PRINT (Digitally Printed)



DIGITAL PRINT

Printing digitally allows you to fully design your tent top any way you would like. With direct-to-fabric printing, this process allows for great detail and beautiful, deep, rich colors.

Don't let your design be held back....Go Digital!



EXAMPLE 1:
Design on any area of the top of the tent

FULL COLOR PRINT (4 Color Process Print // Non-Digital)



The 4 color process screen print option is only available when orders of 12+ full color tent tops are placed.



EXAMPLE 1:
Design on any area of the top of the tent



SQUARE LEG WEIGHTS

works with these tents  

DESCRIPTION	ITEM#	GRAPHIC HEIGHT	GRAPHIC WIDTH	TOTAL HEIGHT	TOTAL WIDTH	TOTAL DEPTH	WEIGHT	MATERIAL
Single Leg Weight	TNT1175	-	-	1.5"	8"	7"	11 lbs per	Coated Metal



SPIKE & ROPE

works with these tents   

DESCRIPTION	ITEM#	GRAPHIC HEIGHT	GRAPHIC WIDTH	TOTAL HEIGHT	TOTAL WIDTH	TOTAL DEPTH	WEIGHT	MATERIAL
Hardware	TNT1195	-	-	36" per rope 11" per stake	0.5" Diameter Rope	2"	1.25 lbs	Nylon Rope & Steel Spikes



STABILIZING BAR

works with these tents  

DESCRIPTION	ITEM#	GRAPHIC HEIGHT	GRAPHIC WIDTH	TOTAL HEIGHT	TOTAL WIDTH	TOTAL DEPTH	WEIGHT	MATERIAL
Hardware	TNT1495	-	-	2"	120"	2"	4 lb	Aluminum



ROUND HEAVY LEG WEIGHTS

works with these tents   

DESCRIPTION	ITEM#	GRAPHIC HEIGHT	GRAPHIC WIDTH	TOTAL HEIGHT	TOTAL WIDTH	TOTAL DEPTH	WEIGHT	MATERIAL
Single Leg Weight	TNT1470	-	-	1.5"	14"	14"	39 lbs	Coated Metal



FEATHER FLAG TENT MOUNT

works with these tents  

DESCRIPTION	ITEM#	GRAPHIC HEIGHT	GRAPHIC WIDTH	TOTAL HEIGHT	TOTAL WIDTH	TOTAL DEPTH	WEIGHT	MATERIAL
Tent Mount	TNT1425	-	-	8"	2"	5"	2 lbs	Stainless Steel



FULL WALL

works with these tents



SS - Single Sided Print

DS - Double Sided Print

DESCRIPTION	SS	ITEM#	DS	ITEM#	GRAPHIC HEIGHT	GRAPHIC WIDTH	TOTAL HEIGHT	TOTAL WIDTH	TOTAL DEPTH	WEIGHT	MATERIAL
5' Full Wall		TNT1135		TNT1325	72.5"	57.5"	-	-	-	4 lbs	Poly 600
7' Full Wall		TNT1080		TNT1315	72.5"	80"	-	-	-	5 lbs	Poly 600
10' Full Wall		TNT1025		TNT1305	72.5"	115"	-	-	-	5.5 lbs	Poly 600
15' Full Wall		TNT1260		TNT1335	72.5"	168"	-	-	-	8 lbs	Poly 600
20' Full Wall		TNT1285		TNT1295	72.5"	225"	-	-	-	11 lbs	Poly 600



FULL WALL with WINDOW

works with these tents



SS - Single Sided Print

DS - Double Sided Print

DESCRIPTION	SS	ITEM#	DS	ITEM#	GRAPHIC HEIGHT	GRAPHIC WIDTH	TOTAL HEIGHT	TOTAL WIDTH	TOTAL DEPTH	WEIGHT	MATERIAL
5' Window Wall		TNT1945		TNT1950	72.5"	57.5"	-	-	-	4 lbs	Poly 600
7' Window Wall		TNT1955		TNT1960	72.5"	80"	-	-	-	5 lbs	Poly 600
10' Window Wall		TNT1965		TNT1970	72.5"	115"	-	-	-	5.5 lbs	Poly 600
15' Window Wall		TNT1975		TNT1980	72.5"	168"	-	-	-	8 lbs	Poly 600
20' Window Wall		TNT1985		TNT1990	72.5"	225"	-	-	-	11 lbs	Poly 600



ZIPPER ENTRANCE WALL

works with these tents



SS - Single Sided Print

DS - Double Sided Print

DESCRIPTION	SS	ITEM#	DS	ITEM#	GRAPHIC HEIGHT	GRAPHIC WIDTH	TOTAL HEIGHT	TOTAL WIDTH	TOTAL DEPTH	WEIGHT	MATERIAL
5' Zipper Wall		TNT1995		TNT2000	72.5"	57.5"	-	-	-	4 lbs	Poly 600
7' Zipper Wall		TNT2005		TNT2010	72.5"	80"	-	-	-	5 lbs	Poly 600
10' Zipper Wall		TNT2015		TNT2020	72.5"	115"	-	-	-	5.5 lbs	Poly 600
15' Zipper Wall		TNT2025		TNT2030	72.5"	168"	-	-	-	8 lbs	Poly 600
20' Zipper Wall		TNT2035		TNT2040	72.5"	225"	-	-	-	11 lbs	Poly 600



HALF WALL

works with these tents



SS - Single Sided Print

DS - Double Sided Print

DESCRIPTION	SS	ITEM#	DS	ITEM#	GRAPHIC HEIGHT	GRAPHIC WIDTH	TOTAL HEIGHT	TOTAL WIDTH	TOTAL DEPTH	WEIGHT	MATERIAL
5' Half Wall		TNT1140		TNT1330	30"	57.5"	-	-	-	2.5 lbs	Poly 600
7' Half Wall		TNT1085		TNT1320	30"	80"	-	-	-	4 lbs	Poly 600
10' Half Wall		TNT1030		TNT1310	30"	115"	-	-	-	5 lbs	Poly 600
-	-	-	-	-	-	-	-	-	-	-	-
-	-	-	-	-	-	-	-	-	-	-	-

★ Don't forget to purchase 10' Half Wall Stabilizing Bar

BEACH UMBRELLAS



C-SERIES STEEL BEACH UMBRELLA

The C series white beach umbrella frame is made of durable steel and has a 45° degree break in the frame to give you the ability to shade yourself no matter where the sunshine is coming from. Umbrella tops can be digitally or screen printed. **Screen printed pieces can be ordered at a minimum quantity of 25 pieces.**

DESCRIPTION	ITEM#	GRAPHIC HEIGHT	GRAPHIC WIDTH	TOTAL HEIGHT	TOTAL WIDTH	TOTAL DEPTH	WEIGHT	MATERIAL
Style 1 - Digital Printed Top	UMB1020	80"	80"	-	-	-	3 lbs	200D Poly
Style 2 - Digital Printed Top	UMB1025	80"	80"	-	-	-	3 lbs	200D Poly
Style 3 - Digital Printed Top	UMB1030	80"	80"	-	-	-	3 lbs	200D Poly
Style 4 - Digital Printed Top	UMB1035	80"	80"	-	-	-	3 lbs	200D Poly
Style 1 - Screen Printed Top	UMB1075	80"	80"	-	-	-	3 lbs	200D Poly
Style 2 - Screen Printed Top	UMB1080	80"	80"	-	-	-	3 lbs	200D Poly
Style 3 - Screen Printed Top	UMB1085	80"	80"	-	-	-	3 lbs	200D Poly
Style 4 - Screen Printed Top	UMB1090	80"	80"	-	-	-	3 lbs	200D Poly
C-Series Steel Frame	UMB1000	-	-	93"	105"	-	5 lbs	Steel

C & E SERIES PRINT & FINISHING OPTIONS

PRINT TOP STYLE

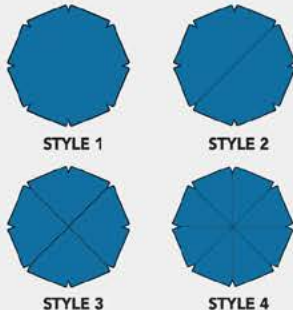

FINISHING



PRINTING OPTIONS

SCREEN PRINT

- Pick your background color
- Pick your screen print location
- Each location of imprint counts as 1 graphic print.





E-SERIES STEEL BEACH UMBRELLA

The E series white patio umbrella frame stands straight up and is made of durable steel. Promote your company and shade yourself in style. Umbrella tops can be digitally or screen printed. **Screen printed pieces can be ordered at a minimum quantity of 25 pieces.**

DESCRIPTION	ITEM#	GRAPHIC HEIGHT	GRAPHIC WIDTH	TOTAL HEIGHT	TOTAL WIDTH	TOTAL DEPTH	WEIGHT	MATERIAL
Style 1 - Digital Printed Top	UMB1020	80"	80"	-	-	-	3 lbs	200D Poly
Style 2 - Digital Printed Top	UMB1025	80"	80"	-	-	-	3 lbs	200D Poly
Style 3 - Digital Printed Top	UMB1030	80"	80"	-	-	-	3 lbs	200D Poly
Style 4 - Digital Printed Top	UMB1035	80"	80"	-	-	-	3 lbs	200D Poly
Style 1 - Screen Printed Top	UMB1075	80"	80"	-	-	-	3 lbs	200D Poly
Style 2 - Screen Printed Top	UMB1080	80"	80"	-	-	-	3 lbs	200D Poly
Style 3 - Screen Printed Top	UMB1085	80"	80"	-	-	-	3 lbs	200D Poly
Style 4 - Screen Printed Top	UMB1090	80"	80"	-	-	-	3 lbs	200D Poly
E-Series Steel Frame	UMB1005	-	-	93"	105"	-	4 lbs	Steel

C & E SERIES WATER BASE

An easy refillable plastic water base to keep your patio umbrella standing steady and helping you stay shaded.



DESCRIPTION	ITEM#	GRAPHIC HEIGHT	GRAPHIC WIDTH	TOTAL HEIGHT	TOTAL WIDTH	TOTAL DEPTH	WEIGHT	MATERIAL
Water Base	TNT1365	-	-	17"	17"	5.5"	3 lbs without water 50.5 lbs with water	Plastic

PATIO UMBRELLAS

PATIO UMBRELLAS

Our patio umbrella canopies are beautifully crafted of 200 D polyester. Graphics are printed with dispersed dyes and materials are pre-treated to ensure long-lasting color and durability. The canopy is water repellent and weather resistant. We can digitally produce one piece or many pieces with full graphics. We can also screen print individual color locations. We have added a new line of umbrellas that offer more frame options or a sleek, modern style.



6-PANEL WOOD UMBRELLA

Our 6-panel wooden, framed patio umbrella offers a sturdy design with a touch of elegance.

DESCRIPTION	ITEM#	GRAPHIC HEIGHT	GRAPHIC WIDTH	TOTAL HEIGHT	TOTAL WIDTH	TOTAL DEPTH	WEIGHT	MATERIAL
Digital Printed Top without Valance	UMB1055	92"	80"	-	-	-	3 lbs	200D Poly
Digital Print Top with Valance	UMB1065	106"	96"	-	-	-	3.5 lbs	200D Poly
Screen Print Top without Valance	UMB1095	92"	80"	-	-	-	3 lbs	200D Poly
Screen Print Top with Valance	UMB1100	106"	96"	-	-	-	3.5 lbs	200D Poly
6 Panel Umbrella Wood Frame	UMB1040	-	-	90"	84"	12"	9.5 lbs	Wood

FINISHING TOP OPTIONS

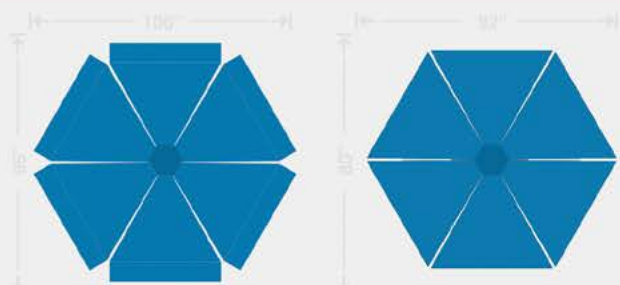

WITH VALANCE

WITHOUT VALANCE

PRINTING OPTIONS

FULL DIGITAL

- Print FULL Tent Top
- Print single graphic in any location
- Print custom message on valance

SCREEN PRINT

- Pick your background color
- Pick your screen print location
- Each location of imprint counts as 1 graphic print.

SCREEN PRINT COLORS



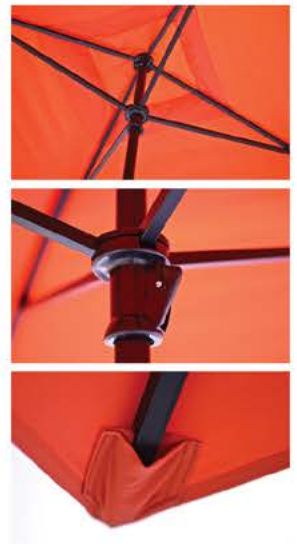

4-PANEL ALUMINUM UMBRELLA

This 4-panel aluminum patio umbrella is sturdy and boasts a sleek and clean modern design.

DESCRIPTION	ITEM#	GRAPHIC HEIGHT	GRAPHIC WIDTH	TOTAL HEIGHT	TOTAL WIDTH	TOTAL DEPTH	WEIGHT	MATERIAL
Digital Printed Top without Valance	UMB1050	88"	88"	-	-	-	3 lbs	200D Poly
Digital Print Top with Valance	UMB1060	104"	104"	-	-	-	3.5 lbs	200D Poly
Screen Print Top without Valance	UMB1105	88"	88"	-	-	-	3 lbs	200D Poly
Screen Print Top with Valance	UMB1110	104"	104"	-	-	-	3.5 lbs	200D Poly
4 Panel Umbrella Aluminum Frame	UMB1045	-	-	102"	78"	12"	7 lbs	Aluminum

FINISHING TOP OPTIONS

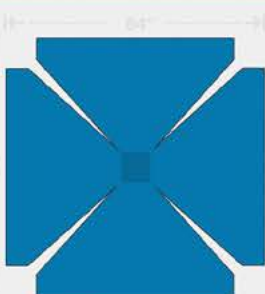

WITH VALANCE



WITHOUT VALANCE

PRINTING OPTIONS

FULL DIGITAL

- Print FULL Tent Top
- Print single graphic in any location
- Print custom message on valance

SCREEN PRINT

- Pick your background color
- Pick your screen print location
- Each location of imprint counts as 1 graphic print.

SCREEN PRINT COLORS



WOOD AND ALUMINUM UMBRELLA BASES

DESCRIPTION	ITEM#	GRAPHIC HEIGHT	GRAPHIC WIDTH	TOTAL HEIGHT	TOTAL WIDTH	TOTAL DEPTH	WEIGHT	MATERIAL
Round Base	UMB1010	-	-	10"	20"	20"	48.5 lbs	Metal
Square Base	UMB1070	-	-	18"	18"	9"	22.5 lbs	Metal

CUSTOM WALLPAPER

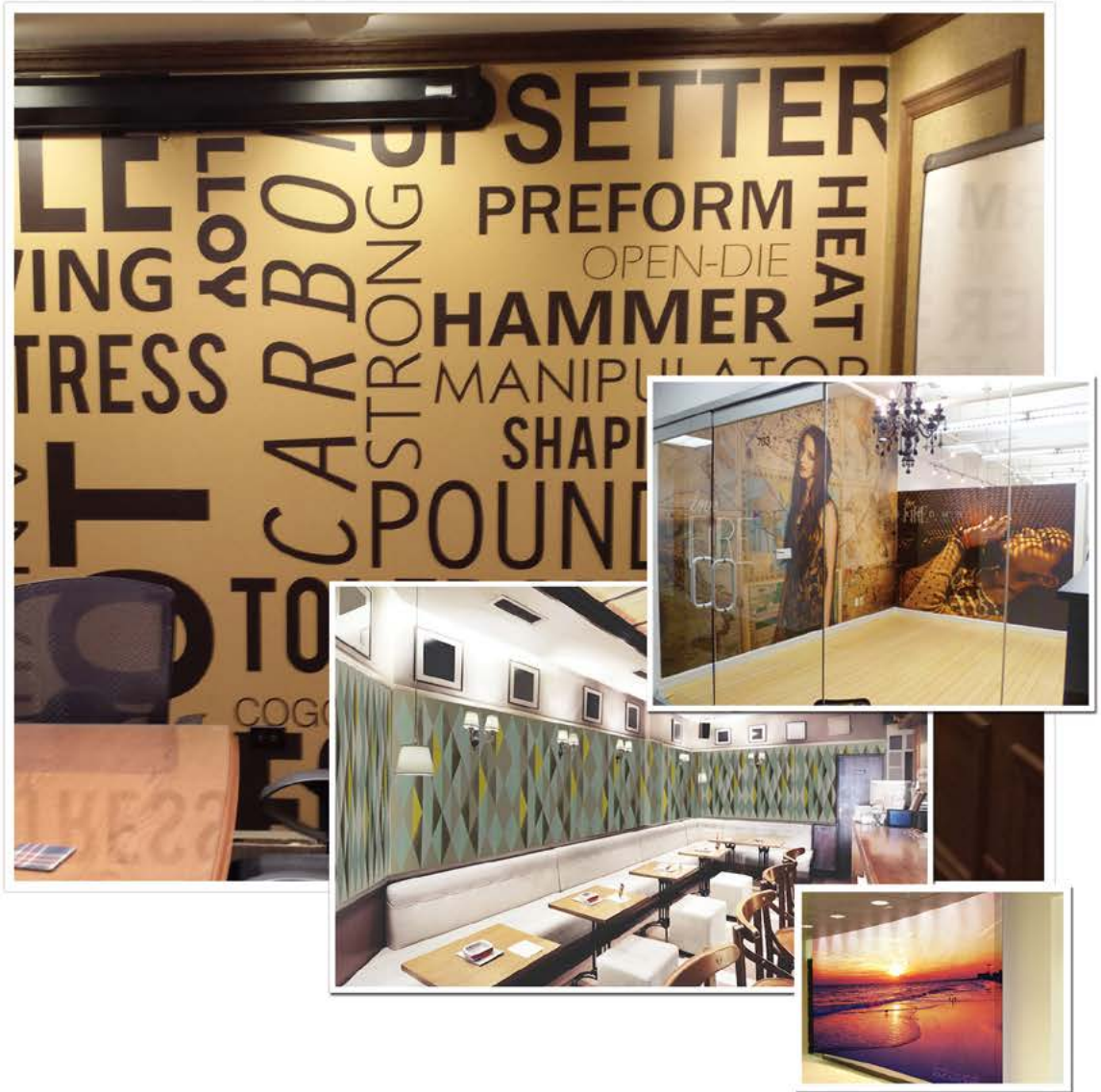

CUSTOM PRINTED WALLPAPER

With our custom-printed wallpapers, your company lobby can have a dramatic floor-to-ceiling mural showing your products, city, logo or history of the company. Your restaurant can have entire walls of old photos or scenery to set the right mood. Retail stores can have custom wallpaper that strengthens their branding.

Our custom wallpaper is printed on 15 oz commercial grade vinyl with UV cured inks that are solvent free, washable and will not fade. The images we print are as durable as those on store bought wallpaper. Our standard material has a nice, smooth feel and is recommended for all styles of applications.

Call one of our customer service representatives for more information regarding your custom wallpaper needs.



WORKS GREAT ON CLOTHES AS WELL

ADHESIVE WALL FABRIC

WALLTEX SELF-ADHESIVE FABRIC

Use our removable wallpaper materials where you don't want to make a permanent installation. It sticks great to drywall, metal, glass, and works great on clothes as well. It comes with an adhesive back and a release paper, so if you are a little bit handy you can install it yourself.

This is a polyester fabric with "sticky note" adhesive on the back. It's good for at least a few years, comes off easily, and smaller pieces can be moved and re-applied. It's also great for window displays and is transparent enough to be backlit.

This material is not waterproof.

Call one of our customer service representatives for more information regarding your custom design and needs.

